

VIVI® 维卫

VIVI® 维卫

SMART TOILET CATALOG



Website

Zhejiang VIVI Electronic Sanitary Ware Co., Ltd

No.2999,Jianan Avenue, Taizhou Bay New District,

Taizhou,Zhejiang, 318014 China

Web: www.vivichina.com

A white smart toilet is positioned in a modern bathroom. The toilet is sleek and minimalist, set against a dark grey marble wall. To the right, a large window offers a panoramic view of a city skyline under a clear blue sky. The floor is made of light-colored marble tiles with dark veining.

PRODUCT CATALOG

ABOUT US 01

Auto induction smart toilet

V90	6
Q3-GS	7
D5-GS	8
Q5-GS	9

Foot touch smart toilet

D3-GF	10
-------	----

Wall mounted smart toilet with water tank inside wall

WZ-28	11
WZ-28X	12
WZ-03	13

Wall mounted smart toilet with concealed water tank

WS-28X	14
WS-02	15

Standard smart toilet

V9-T	17
V8-CB	18
E3-G8	19

Semi smart toilet

SS-01	20
SS-06	21

Concealed water tank smart toilet

VX-BY	22
VX-WY	23

Smart toilet seat

V-B521	24
V-B520	25
V-365	26

Function list 27

ABOUT US

ZHEJIANG VIVI ELECTRONIC SANITARY WARE CO., LTD. was established in 1992. VIVI is highly engaged in design, research, innovation, manufacturing and sales of smart toilet. VIVI is the only enterprise owning the utility patent "Concealed female washing nozzle" in China. With 32 years experiences in product research and development, VIVI is committed to bringing healthy and safe intelligent sanitary products to customers.

OUR FACTORY

VIVI has established professional teams including R&D, production, quality control and aftersales. VIVI has a production area of 60000 square meters and an annual production capacity of 400000 sets.

OUR PRODUCTS

VIVI has dedicated in the industry of smart toilet for 32 years. VIVI has developed multiple series of smart toilet and smart toilet seats, semi smart toilet, smart toilet with and without water tank. Our factory has obtained ISO 9001 certification, most products have obtained CE and CQC certification.

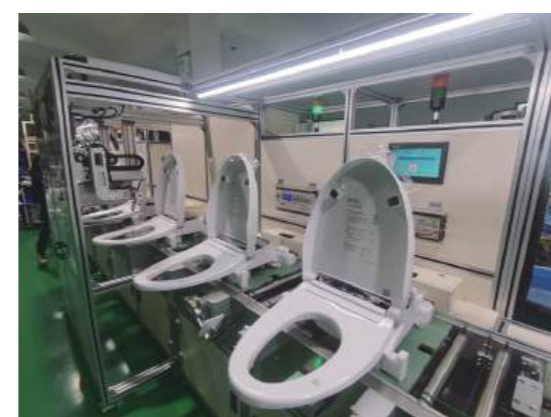



CONCEALED FEMALE WASHING NOZZLE

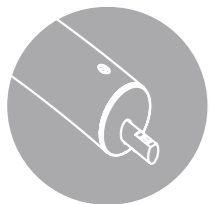

Special design for female to reduce the risk of cross infection.
Porous water outlet allows customers to enjoy a comfortable washing experience.

INSTANT WATER HEATING SYSTEM

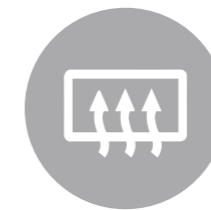

Build-in ceramic heating rod achieves water and electricity separation.

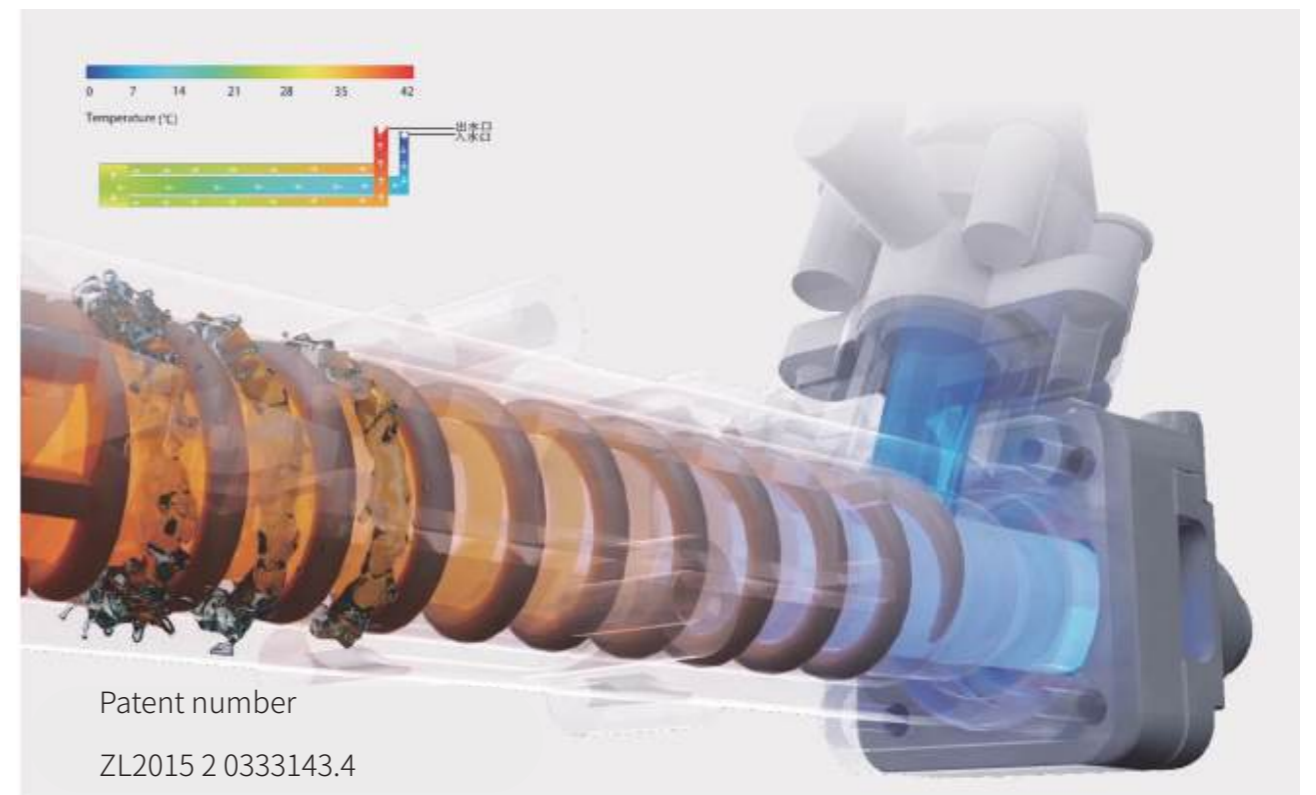



Model: V90

Auto induction smart toilet

Size: 701*415*486
 Mix pit spacing: 305/400mm
 Flushing method: Siphon flushing

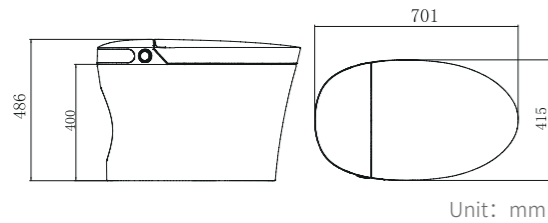

Model: Q3-GS

Auto induction smart toilet

Size: 720*435*485
 Mix pit spacing: 305/400mm
 Flushing method: Siphon flushing

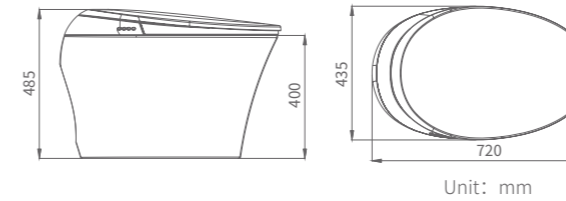

Selling Points



Basic functions



Selling Points



Basic functions





Model: D5-GS

Auto induction smart toilet

Size: 695*429*480
 Mix pit spacing: 305/400mm
 Flushing method: Siphon flushing

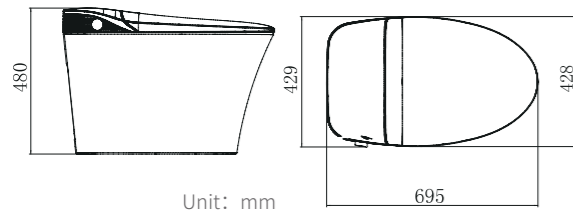

Model: Q5-GS

Auto induction smart toilet

Size: 715*427*501
 Mix pit spacing: 305/400mm
 Flushing method: Siphon flushing

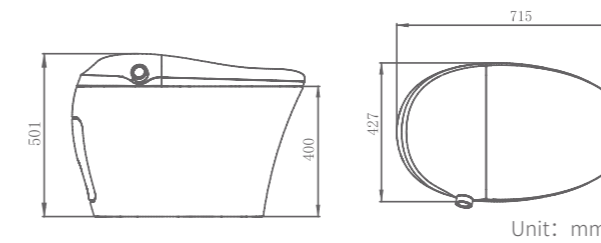

Selling Points

Bluetooth
 Electrolyzed Water Sterilization

Automatic Flip



Basic functions



Accessory Hand held cleaning spray gun



Selling Points

Foot touch button

Automatic Flip



Basic functions



Model: D3-GF

Foot touch smart toilet

Size: 720*435*480
 Mix pit spacing: 305/400mm
 Flushing method: Siphon flushing

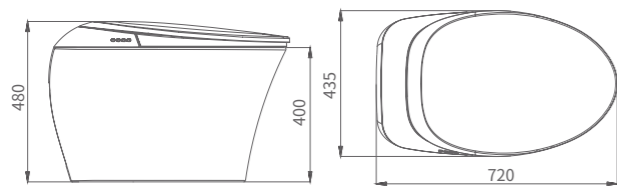

Unit: mm



Model: WZ-28

Wall mounted smart toilet with water tank inside wall

Size: 609*404*365
 Material : Ceramics and ABS
 Flushing Method: Wall drainage

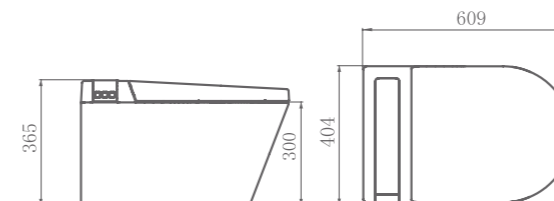

Unit: mm



Selling Points



Basic functions



Selling Points



Basic functions

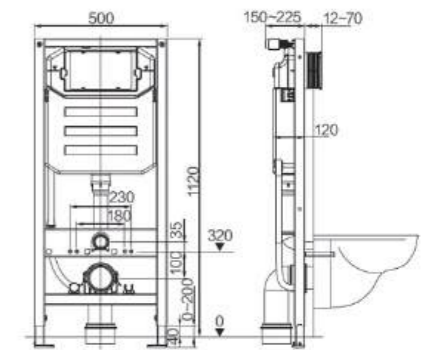

Tank support height : 820/1120mm

Model: WZ-28X

Wall mounted smart toilet with water tank inside wall

Size: 613*403*363
Material : Ceramics and ABS
Flushing Method: Wall drainage

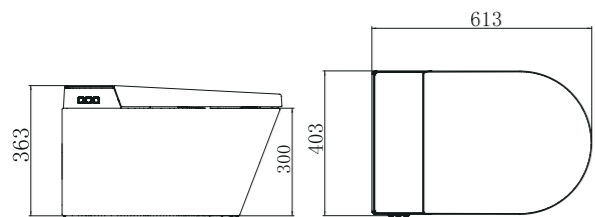

Unit: mm



Model: WZ-03

Wall mounted smart toilet with water tank inside wall

Size: 613*403*363
Material : Ceramics and ABS
Flushing Method: Wall drainage

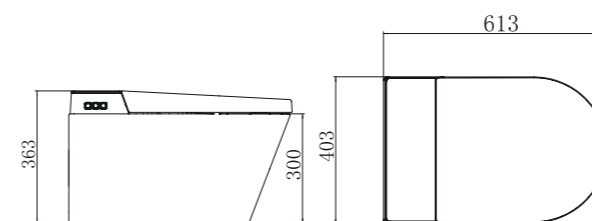

Unit: mm



Selling Points



Foot touch control mode



Basic functions



Selling Points



Foot touch control



Basic functions



Model : WS-28X

Wall mounted smart toilet with concealed water tank

Size: 613*403*363
 Material : Ceramics and ABS
 Flushing Method: Wall drainage



Selling Points



Basic functions



Model: WS-02

Wall mounted smart toilet with concealed water tank

Size: 613*404*363
 Material : Ceramics and ABS
 Flushing Method: Wall drainage



Selling Points



Basic functions



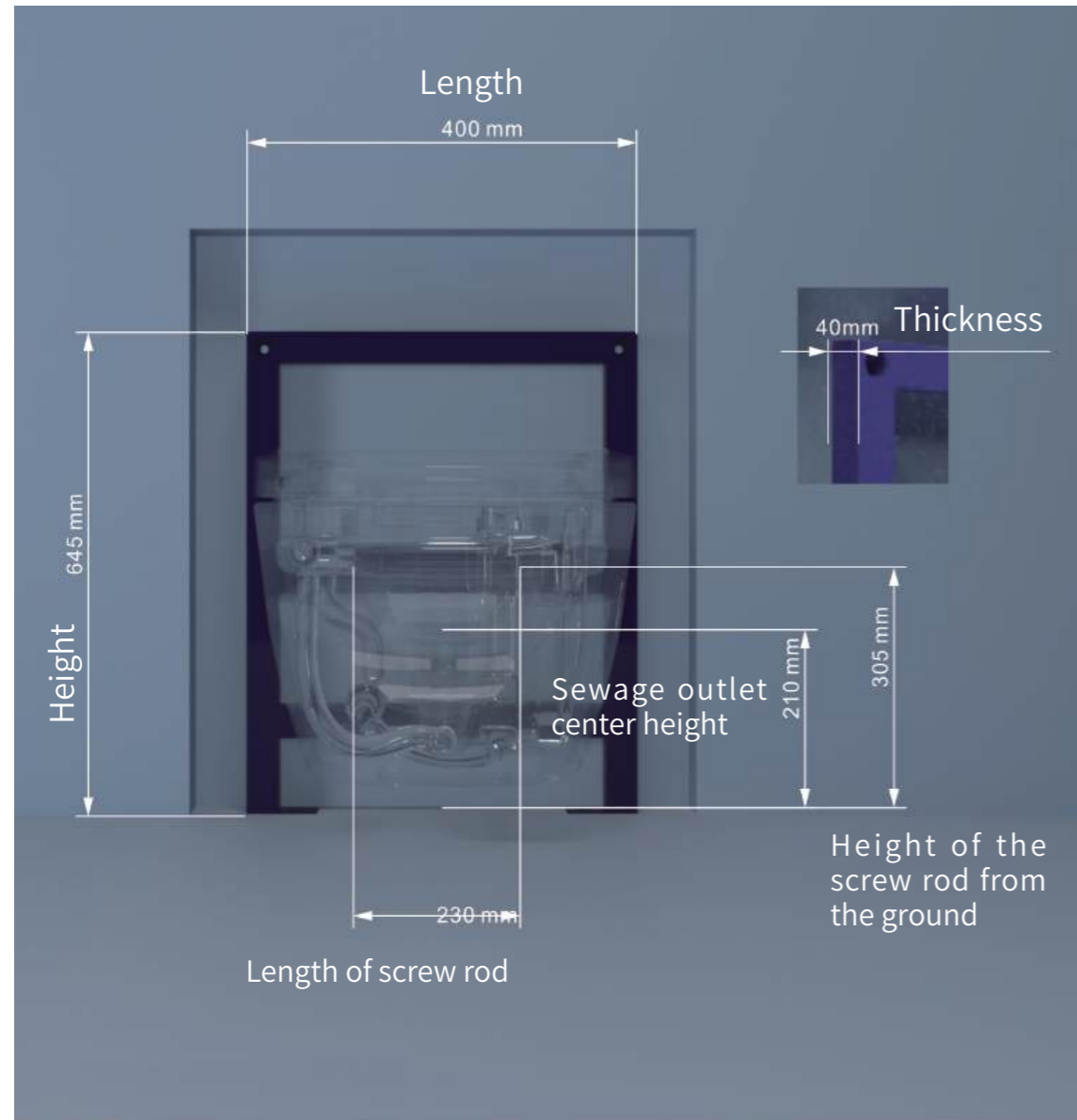

Size of tank support (WS-28X, WS-02)



Model: V9-T

Standard smart toilet

Size: 740*525*485

Mix pit spacing: 305/400mm

Flushing method: Siphon flushing

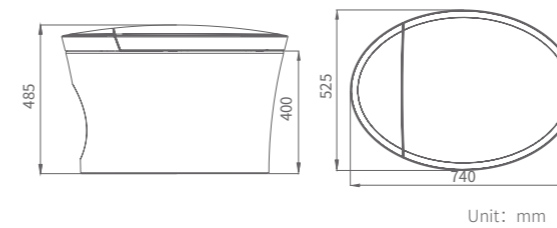

Selling Points



Foot touch control



Basic functions





Model: V8-CB

Standard smart toilet

Size: 695*415*475
 Mix pit spacing: 305/400mm
 Flushing method: Siphon flushing

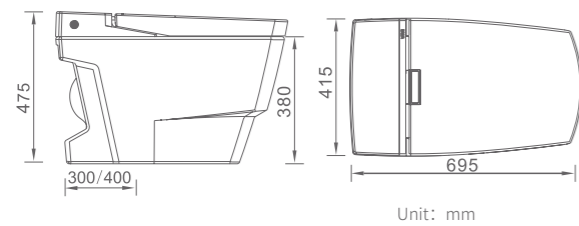

Model: E3-G8

Standard smart toilet

Size: 710*412*477
 Mix pit spacing: 305/400mm
 Flushing method: Siphon flushing

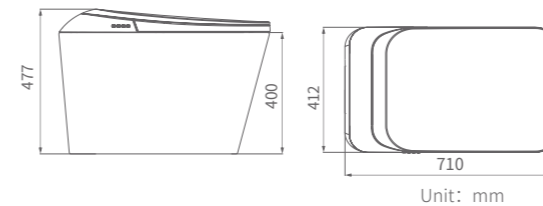

Selling Points

Foot touch control



Basic functions



Selling Points

Foot touch control



Basic functions

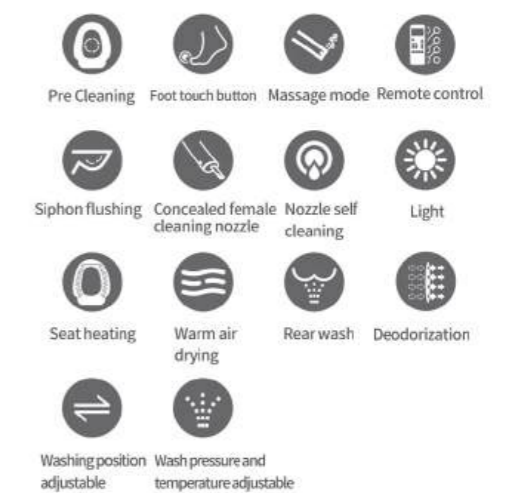



Model: SS-01

Semi smart toilet

Size: 712*426*452
 Mix pit spacing: 305/400mm
 Flushing method: Siphon flushing

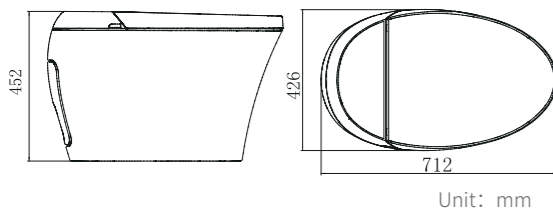

Model: SS-06

Semi smart toilet

Size: 611*404*463
 Mix pit spacing: 305/400mm
 Flushing method: Siphon flushing

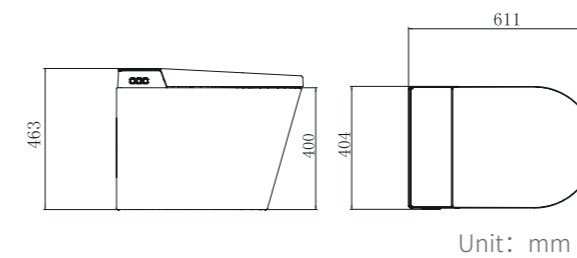

Selling Points

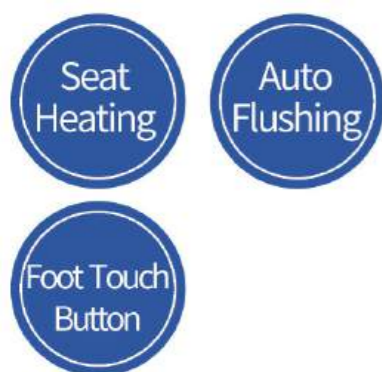

Basic functions



Selling Points



Basic functions



Model: VX-BY

Concealed water tank smart toilet

Size: 694*421*488
 Mix pit spacing: 305/400mm
 Flushing method: Siphon flushing

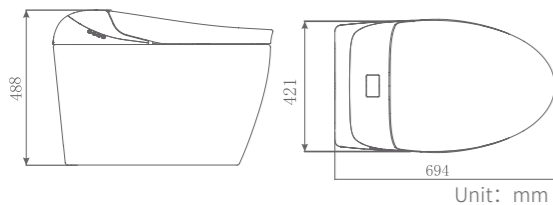

Model: VX-WY

Concealed water tank smart toilet

Size: 609*404*465
 Mix pit spacing: 305/400mm
 Flushing method: Siphon flushing

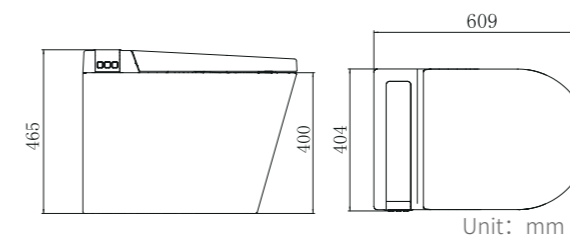

Selling Points



Foot touch control



Basic functions



Selling Points



Foot touch control



Basic functions



Model: V-B521

Smart toilet seat

Size: 521*460*100

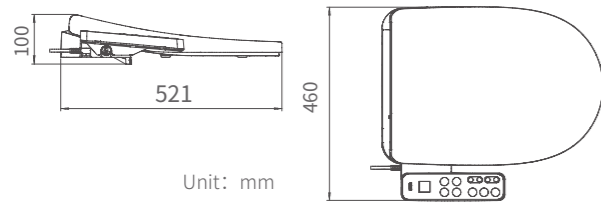

Model: V-B520

Smart toilet seat

Size: 520*460*100

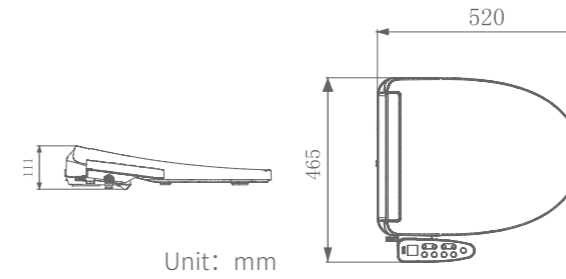

Selling Points

- Female wash
- Rear wash
- Seat heating
- Concealed female cleaning nozzle

Basic functions

- Rear wash
- Female wash
- light
- Water temperature adjustable
- Seat heating
- Washing position adjustable
- Water pressure adjustable
- Nozzle self cleaning
- Seat temperature adjustable
- Concealed female cleaning nozzle

Selling Points

- Female wash
- Rear wash
- Warm air drying
- Seat heating

Basic functions

- Rear wash
- Female wash
- Warm air drying
- Water temperature adjustable
- Seat heating
- Washing position adjustable
- Water pressure adjustable
- Nozzle self cleaning
- Seat temperature adjustable
- light



Model: V-365

Smart toilet seat

Material: PP
 Rated voltage: 220V
 Size: 505*365*85 mm

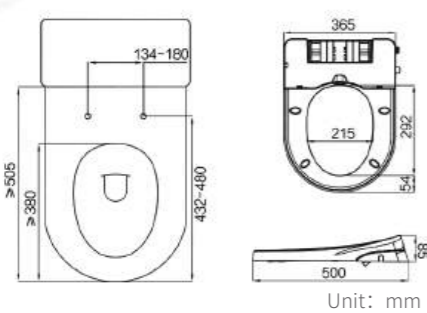

Buffer Cover plate



Easy to use
 Operate without electricity



Nozzle self clean

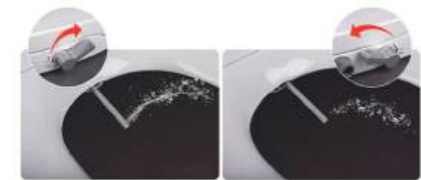

Rear Wash Female Wash



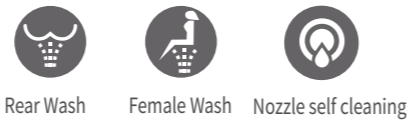

Basic functions







FUNCTION LIST

MODEL	V90	Q3-GS	D5-GS	Q5-GS
FUNCTIONS				
Wash water heating	●	●	●	●
Rear wash	●	●	●	●
Female wash	●	●	●	●
Warm air drying	●	●	●	●
Nozzle self cleaning	●	●	●	●
Adjustable water temperature	●	●	●	●
Adjustable wash pressure	●	●	●	●
Adjustable washing position	●	●	●	●
Seat heating	●	●	●	●
Light	sensing lamp	●	●	●
Concealed female washing nozzle	●	●	●	●
Massage mode	●	●	●	●
Auto flush	●	●	●	●
Knob	●	—	●	●
LED screen	—	—	—	—
Electrolytic water sterilization	●	—	●	—
UV sterilization	●	—	—	—
Soft-close system	●	●	●	●
Foot touch control	●	●	●	●
Auto Open (Lid/Seat)	●	●	●	●
Remote control	●	●	●	●
Hand hold spray gun	●	—	●	—
Power saving	●	●	●	●
Water tank	—	—	—	—
Backup power (Flush only)	●	●	●	●
Deodorization	●	●	●	●
Instant heating	●	●	●	●
Hemorrhoid care mode	●	●	●	●
Leakage protection	●	●	●	●
Foot touch control (open lid/open seat / flush)	●	●	●	●
Emergency flushing	●	●	●	●
Ambience light	●	—	—	—
Wash down	—	—	—	—
Siphon jet flushing	●	●	●	●
Remote control to open (Lid/Seat)	●	●	●	●





“●” YES “—” NO

MODEL	D3-GF	V9-T	V8-CB	E3-G8
				
FUNCTIONS				
Wash water heating	●	●	●	●
Rear wash	●	●	●	●
Female wash	●	●	●	●
Warm air drying	●	●	●	●
Nozzle self cleaning	●	●	●	●
Adjustable water temperature	●	●	●	●
Adjustable wash pressure	●	●	●	●
Adjustable washing position	●	●	●	●
Seat heating	●	●	●	●
Light	●	●	●	●
Concealed female washing nozzle	●	●	●	●
Massage mode	●	●	●	●
Auto flush	●	●	●	●
Knob	—	—	—	—
LED screen	—	—	—	—
Electrolytic water sterilization	—	—	—	—
UV sterilization	—	—	—	—
Soft-close system	●	●	●	●
Foot touch control	●	●	●	●
Auto Open (Lid/Seat)	—	—	—	—
Remote control	●	●	●	●
Hand hold spray gun	—	—	—	—
Power saving	●	●	●	●
Water tank	—	—	—	—
Backup power (Flush only)	●	●	●	●
Deodorization	●	●	●	●
Instant heating	●	●	●	●
Hemorrhoid care mode	●	●	●	●
Leakage protection	●	●	●	●
Foot touch control (open lid/open seat / flush)	●	flush	flush	flush
Emergency flushing	●	●	●	●
Ambience light	—	—	—	—
Wash down	—	—	—	—
Siphon jet flushing	●	●	●	●
Remote control to open (Lid/Seat)	●	—	—	—





“●” YES “—” NO

MODEL	SS-01	SS-06	VX-BY	VX-WY
				
FUNCTIONS				
Wash water heating	—	—	●	●
Rear wash	—	—	●	●
Female wash	—	—	●	●
Warm air drying	—	—	●	●
Nozzle self cleaning	—	—	●	●
Adjustable water temperature	—	—	●	●
Adjustable wash pressure	—	—	●	●
Adjustable washing position	—	—	●	●
Seat heating	●	●	●	●
Light	●	●	●	●
Concealed female washing nozzle	—	—	●	●
Massage mode	—	—	●	●
Auto flush	●	●	●	●
Knob	—	—	—	—
LED screen	—	—	—	—
Electrolytic water sterilization	—	—	—	●
UV sterilization	—	—	—	—
Soft-close system	●	●	●	●
Foot touch control	●	●	●	●
Auto Open (Lid/Seat)	—	—	—	—
Remote control	—	—	●	●
Hand hold spray gun	—	—	—	—
Power saving	●	●	●	●
Water tank	—	●	●	●
Backup power (Flush only)	●	—	—	—
Deodorization	—	—	●	●
Instant heating	—	—	●	●
Hemorrhoid care mode	—	—	●	●
Leakage protection	●	●	●	●
Foot touch control (open lid/open seat / flush)	flush	flush	flush	flush
Emergency flushing	●	—	—	—
Ambience light	—	—	—	—
Wash down	—	—	—	—
Siphon jet flushing	●	●	●	●
Remote control to open (Lid/Seat)	—	—	—	—

“●” YES “—” NO

MODEL	WZ-03	WZ-28	WZ-28X	WS-28X
FUNCTIONS				
Wash water heating	—	●	●	●
Rear wash	—	●	●	●
Female wash	—	●	●	●
Warm air drying	—	●	●	●
Nozzle self cleaning	—	●	●	●
Adjustable water temperature	—	●	●	●
Adjustable wash pressure	—	●	●	●
Adjustable washing position	—	●	●	●
Seat heating	●	●	●	●
Light	●	●	●	●
Concealed female washing nozzle	—	●	●	●
Massage mode	—	●	●	●
Auto flush	●	●	●	●
Knob	—	—	—	—
LED screen	—	●	—	—
Electrolytic water sterilization	—	●	●	—
UV sterilization	—	—	—	—
Soft-close system	●	●	●	●
Foot touch control	●	●	●	—
Auto Open (Lid/Seat)	●	●	●	●
Remote control	—	●	●	●
Hand hold spray gun	—	—	—	—
Power saving	—	●	●	●
Water tank	●	●	●	●
Backup power (Flush only)	—	—	—	—
Deodorization	—	●	●	—
Instant heating	—	●	●	●
Hemorrhoid care mode	—	●	●	●
Leakage protection	●	●	●	●
Foot touch control (open lid/open seat / flush)	●	—	●	—
Emergency flushing	●	●	●	—
Ambience light	—	—	●	—
Wash down	●	●	●	—
Siphon jet flushing	—	—	—	●
Remote control to open (Lid/Seat)	—	●	●	●

“●” YES “—” NO

MODEL	WS-02	V-B521	V-B520	V-365
FUNCTIONS				
Wash water heating	—	—	—	—
Rear wash	—	●	●	●
Female wash	—	●	●	●
Warm air drying	—	—	●	—
Nozzle self cleaning	—	●	●	●
Adjustable water temperature	—	●	●	—
Adjustable wash pressure	—	●	●	—
Adjustable washing position	—	●	●	—
Seat heating	●	●	●	—
Light	●	●	●	—
Concealed female washing nozzle	—	●	—	—
Massage mode	—	—	—	—
Auto flush	●	—	—	—
Knob	—	—	—	—
LED screen	—	—	—	—
Electrolytic water sterilization	—	—	—	—
UV sterilization	—	—	—	—
Soft-close system	●	●	●	●
Foot touch control	—	—	—	—
Auto Open (Lid/Seat)	—	—	—	—
Remote control	●	—	—	—
Hand hold spray gun	—	—	—	—
Power saving	—	—	—	—
Water tank	●	—	—	—
Backup power (Flush only)	—	—	—	—
Deodorization	—	—	—	—
Instant heating	—	—	—	—
Hemorrhoid care mode	—	—	—	—
Leakage protection	●	—	—	—
Foot touch control (open lid/open seat / flush)	—	—	—	—
Emergency flushing	—	—	—	—
Ambience light	—	—	—	—
Wash down	—	—	—	—
Siphon jet flushing	●	—	—	—
Remote control to open (Lid/Seat)	●	—	—	—

“●” YES “—” NO

Model: Q5-GS



Model: WS-28X



Model: V90



Model: WZ-28X

