

**FITTED**

**菲 缇**

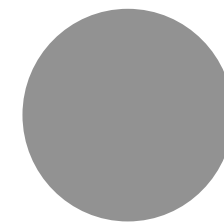

品牌解读  
Brand interpretation

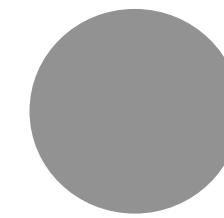

柜类系统  
Cabinet system

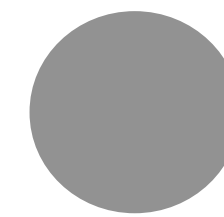

软体系统  
Soft furniture system



FITTED 终端形象展示



FITTED 终端形象展示



## 品牌简介

### Brand introduction

**FITTED** 是一家忠于设计质感,注重产品品质和持续技术创新的现代化家具企业。

**FITTED** 更着重关注与聆听高净值人群对家居空间定制化的个性需求,助力客户实现其家居想象宇宙定制,为其打造更具健康性、品质性与舒适性的家居空间。

**FITTED** 源于对当代生活居住方式的不断追求极致而专注于空间美学及家具工艺细节,产品线覆盖几乎宅邸内所有装饰项,包括但不限于移动家具、衣柜衣帽间系统、厨房橱柜系统、综合柜类系统,专注专业为消费者提供品质更优的顶级私宅、商业空间、全屋整体美学家居的一站式家居整体解决方案,简约的线条和完美的测量比例,搭配具有独特可识别的现代风格,工艺精湛考究,细节把控精益求精,赋能空间美学,唤醒人居理想,传递菲缇家居的美学态度:品质代表生活。

**FITTED** 立志为享受精致生活的国人打造时尚简约的国际化生活环境,传播世界最前沿的奢侈品家居文化理念。FITTED将产品做到极致,用方案空间思维替换产品思维,其全案设计致力使客户实现家居空间定制的高级场景化,打造独属FITTED的更具创意、时尚、科技感的现代极简风格标签。



## 品牌解读

### Brand interpretation

FITTED 的核心特质在于全方位地诠释“意大利制造”的概念，如今，传统与创新完美融合在这一理念中：匠人的技艺让 诞生于现代科技的产品倍显精致，灵巧的双手为精细的工业生产注入一丝细腻与情怀。除了高水平的技术和技能以外，公司还运用精益求精的材质和技术解决方案，以此来展现无可挑剔的细节之美，公司所有部门都秉持对于卓越品质的不懈追求。

The core characteristic of FITTED lies in the comprehensive interpretation of the concept of "Made in Italy". Nowadays, tradition and innovation are perfectly integrated in this concept: The craftsmanship makes products born in modern technology more refined, and dexterous hands are refined industries. Production injects a touch of delicacy and feelings. In addition to high-level technology and skills, the company also uses refined materials and technical solutions to show the beauty of impeccable details. All departments of the company uphold the unremitting pursuit of excellent quality.



# 柜类系统

Cabinet system

健康性、品质性、艺术性融为一体的高定空间

多元素多功能多面交互

沉浸式自由体验感拉满

## 柜类系统

Cabinet system

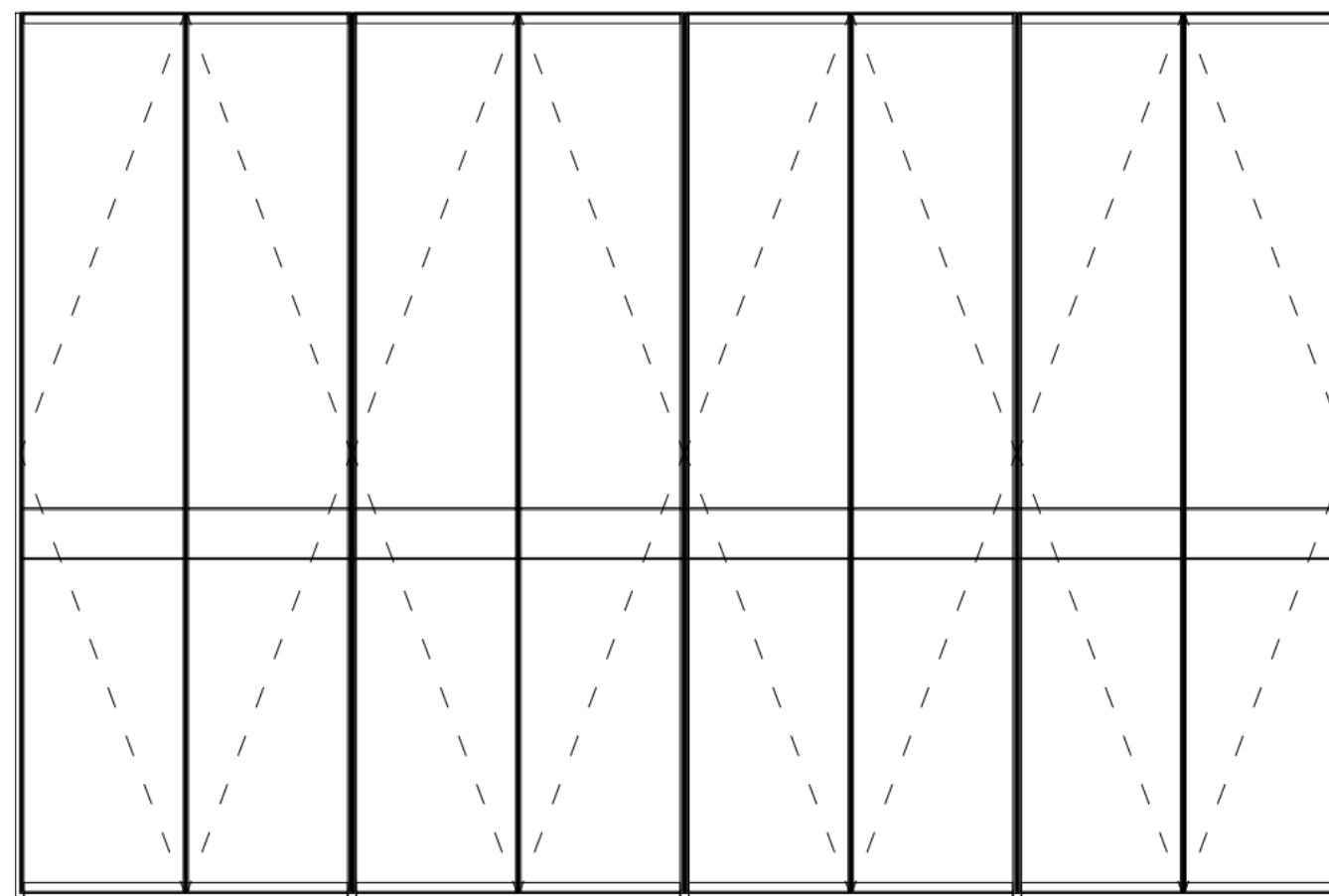

也许很多人关心的仅仅是柜类产品的板材和五金，  
而我们更关心的是其背后的人们健康生活.....



## 菲缇高定品质

不只是产品，更是健康生活方式的倡导

在肆虐全球的疫情暴发后，人们对居家生活的健康指数产生前所未有的关注，兼具健康与收纳功能的柜体家居空间成为潮流。

菲缇柜体系统为客户定制想象的家居空间设计，融合颜值与功能，致力于空间和场景的打造，助力消费者在疫情时期升级家居健康，使得家居空间健康MAX，家庭生活幸福感MAX。

为了保证品质，菲缇严苛选用进口品牌板材与五金配件，囊括板材的国际著名品牌可丽芙与普丽，五金品牌萨耐奇与海蒂诗，给予客户的不止于产品，更多的是健康家居空间之家的解读与探索，引领家居新风尚，与客户共同探寻精致而舒适的生活方式。









## 可丽芙板材

材板中的爱马仕

可丽芙板纹理非常精致，轻松营造低调奢华氛围。

可丽芙Cleaf作为意大利进口板材，不管在外观审美，还是在环保和工艺技术方面，都在业内备受瞩目。所以，被称之为“板材中的爱马仕”，它以其板材世界领先的表面处理，优异稳定的产品品质，和丰富灵活的产品花色配套选择，为众多欧洲顶级家具及橱柜公司所青睐。

菲缇家居产品设计坚持以原创为本，结合高定家居消费市场核心人群核心需求，以成熟优良的工艺手段，模块化的产品标准体系，致力为高定家居目标人群提供优美的设计、优质的产品与更为个性化的整体家居解决方案。



## 普丽®板材

是全球高品质装饰板材的代名词。

板材特性：肌肤般的触感、银离子抗菌技术、抗指纹特性、抗冲击和耐刮擦材质、耐高温特性，以及时间修复技术，在当下更为翘楚，鹤立鸡群，守护室内清新健康环境。

20世纪最伟大的设计师之一 Gio Ponti 先生在1965年评价普丽®板为“首次由人类创造出的非凡的，源于自然而又超越自然的建筑装饰材料”。

## 菲缇高定品质

不只是产品，更是健康生活方式的倡导

菲缇选用进口品牌五金：萨丽奇铰链、海蒂诗轨道，如果说材板是主材料，五金则能使得产品华丽变身，菲缇通过设计、工艺、体验、服务等提高产品的高净值体验感，进而满足客户不同层次的精神需求。





## 萨丽奇铰链 | Salice

意大利进口品牌五金

世界上第一支铰链就是他们发明的，产地意大利。萨丽奇在欧洲有很好的知名度和客户基础，据了解，萨丽奇铰链使用寿命可长达30年，大部分德国和意大利的顶级橱柜几乎都是采用萨丽奇的铰链，更有人曾言道萨丽奇“垄断”了欧洲高端家具五金市场。



## 海蒂诗轨道 | Hettich

德国进口品牌五金

海蒂诗(Hettich)于1888年在德国黑森林创建。

1999年便进驻布局中国市场。这22年来,海蒂诗一直深耕于中国的厨房、住宅、办公家具领域,同时也涉猎中国的地产及酒店工程项目,连续多年荣获中国橱柜行业十大五金品牌。在过去的二十多年里,海蒂诗在中国市场经历了飞速的发展,成为最早为国内消费者熟知并喜爱的世界顶级五金品牌之一。

海蒂诗轨道特点:运行平顺,流畅,同步,稳定,静音阻尼系统。





## 红棉中国设计奖·2021产品设计奖

KAPOK DESIGN AWARDS CHINA - PRODUCT DESIGN WINNER 2021

获奖产品：敞开式组合衣帽柜

获奖企业：上海菲缇家居有限公司

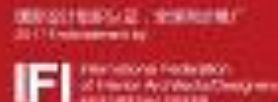

## 菲缇·敞开式组合衣帽柜 | 红棉中国设计奖获奖作品

追求极致产品力的完美映现

以实力打破边界 给消费者多一份自由随性

2021年度“红棉中国设计奖获奖名单”隆重揭晓，菲缇敞开式组合衣帽柜斩获红棉中国设计奖2021「产品设计奖」殊荣。

## 菲缇·敞开式组合衣帽柜 | 红棉中国设计奖获奖作品

菲缇开放式组合衣帽柜追求极致产品力的完美映现，时尚又大气，敞开式衣柜与共面移门的精准搭配，打破边界与冲破束缚，赋予空间最大限度的自由，通过不同组合，呈现无限的可能，给消费者带来恰如其分的美学感受。

菲缇开放式组合衣帽柜是为消费者打造的环保轻奢的高质产品，极具创意的收纳空间，承载的不仅仅是满足收纳的基本的生活需求，更多的应是对健康舒适生活的考量和营造。这当中，空气质量对人体健康至关重要，菲缇极高标准选材和品控，使得每一个产品都是对环保的承诺，让每一件衣物都安心储放。

菲缇开放式组合衣帽柜重新定义生活空间美学，其专业设计使得每一份收纳都情有独钟而变得意义非凡；完备有效的衣柜系统在整合更多功能的同时，兼收并蓄，博采众长，合理运用藏与露的收纳空间整合艺术，让视觉干净，空间更新迭代，生活更舒适。







## 软体系统

### Meeting Room会客厅

- Sofas 沙发
- Armchairs 扶手椅
- Tables 桌子
- sideboards 边柜
- Console tables 倚墙饰托桌
- Chaise Longue 躺椅
- Accessories 配件

### Meeting Room餐厅

- Chairs and stools 椅凳

### Sleep Room卧房

- Beds 床
- Nighe-tables 床头柜



健康性、品质性、艺术性融为一体的高定空间

匠心打造专属舒适区

体验进阶开启躺赢人生

## 软体系统

Soft furniture system

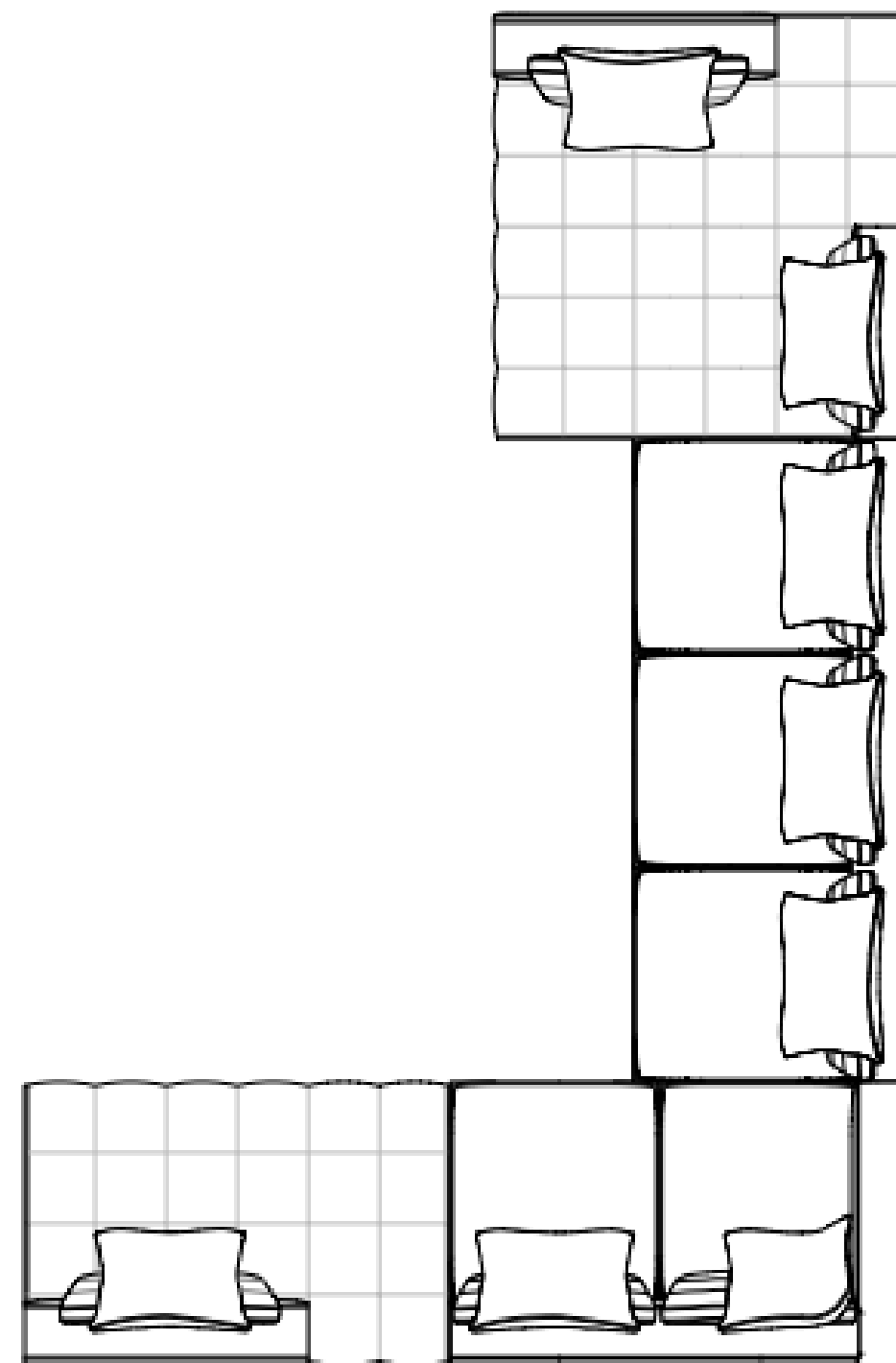





凭借特有的原创性和创新性，可以完美搭配低矮家具，创建具有强烈视觉冲击力的设计方案，从沙发的柔软效果到收纳柜的坚硬质感，从方形的几何造型到非凡的曲线组合，无不呈现出流畅的美感过渡，其设计概念的基础是打造超多组合形式和超高舒适度，值得一提的是，该系列的座垫设计别具一格。不胜枚举的组合方案中包括造型宽大的躺椅沙发，带有弧形座垫。



弯曲有致的造型和珍贵饰面的运用打造了舒适的客厅区域。配以柔软温馨的座椅，和优质大理石设计打造的茶几和边几；每个细节都有助于使整体独特而非凡。





模块化沙发的沙发组合，大尺寸的大理石茶几组合 和极富线条感的扶手椅是日间区域的亮点。 这些 产品虽然由不同的设计师打造而成，但却是 出乎意料的在场景中达到了完美的融合。



沙发组合系列通过其流畅的造型和平衡的圆润线条，探索不同类型的沙发座椅组合，从休闲的小扶手椅、更宽大舒适的扶手椅到沙发，突破经典造型风格，呈现创新解决方案。

其设计在美学上玩味不同材质的搭配创意，比如：用皮革来展现环抱式靠背的弧度及其延伸向下的扶手，用布料来突显靠垫的精致高定元素。

这一系列的各种配置可以随着纵深的变化而呈现出不同的特质，既适用于私密温馨的场景，也可以添加繁复的元素以适用于更宽敞精致的空间。

拥有与生俱来的优雅感和多种多样的组合形式，不仅完美适合于室内家居空间，也是酒店设计项目的个性之选。



沙发和扶手椅采用镀铬金属支撑脚或亮光Pewter色金属饰面，精益求精的细节突显其雅致的造型。产品系列还包括一款扶手椅，椅腿可以选用Moka色白蜡木材质或皮革覆面，这一别致的细节也体现在休闲小扶手椅和餐椅设计中。

每种类型都可以选用各种材料和色彩组合。黑色皮革、织物覆面、镀铬饰面支撑腿的组合方案呈现出70年代的风情，天鹅绒和雪尼尔的组合则更具装饰性。



沙发座椅系列拥有现代经典的气质，通过饱满而又严谨的造型组合加以呈现，采用别具一格的水平线条设计。Lawrence系列的独特之处在于鲜明而又简约的个性，将不同的元素结合在一起，因而极具功能性，能够打造出多种多样的组合，优雅地融入不同的环境。精湛的技艺和创造力打造出拥有超高质量的产品，所使用的鹿皮展现出其价值所在，鹿皮是珍贵天然的材料，其特点在于非凡的柔软触感以及十分明显的颗粒感。

## LEATHER AND MATERIALS

真皮、布艺、大理石和实木，是我们研究的对象和创造的源泉，承托着我们对材料的迷恋。

FITTED 提供类型丰富的材料和饰面效果，您可以根据自己的品味和需求，定制理想的沙发、睡床或其他任何单品家具。

Leather, fabrics, marbles and woods are expressions of our research, creativity and passion for materials. Our vast range of upholsteries and finishes allows you to customize any sofa, bed or piece of furniture according to your taste and needs.

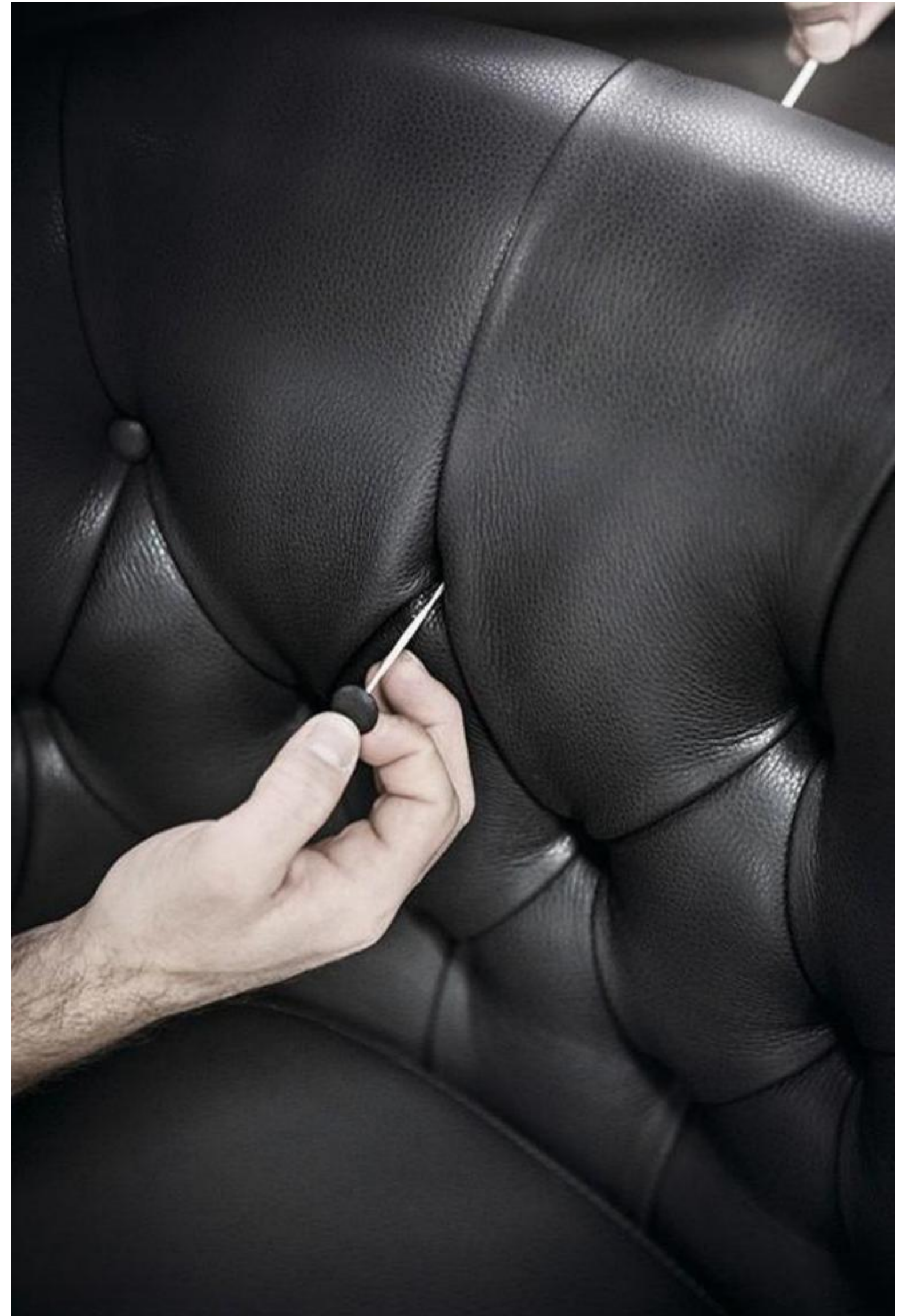

FITTED





通过沙发系列来对居住空间的设计加以创新，运用独具特色的多种元素，搭配别具一格的审美情趣，融入优雅的比例设计和无与伦比的舒适感。组合拥有柔软而包容的线条和超软靠垫，打造温暖舒适的非凡体验。沙发的设计抚慰人心，精致的细节做工重新对传统加以诠释，平添一份具有现代感的古典风情。组合拥有与众不同的个性，造型更加洗练，单组沙发的缝制设计别具一格，展现出图形魅力与现代意味。两种特质融合在一起，打造出“多面玲珑”的组合形式，在一天中的不同时刻，用不同方式来享受沙发上的体验。沙发系列无疑是居住空间的主角，既可以在这里独享私密空间，也可以在这一闲适的环境中与朋友共度美好时光。沙发基座采用挤压铝型材制成，圆边框架和浅铜色的亮光漆使其倍显优雅。边角的连接部件为压铸铝，一丝不苟的细节为沙发基座平添一份精致。沙发的支撑脚采用考究的金属材质并搭配浅铜色的亮光漆，打造出整体的轻量感。



软垫结构基座，除了选择织物覆面以外，还可以选择皮革覆面，这一覆面采用箱包工艺制作而成。高端皮具的理念亦体现在头枕和优雅的“C”形 Flap 隔板上，两者可以和谐地融入到座椅元素中，为组合形式注入生动的节奏。结构基座采用挤压铝型材制成的薄板作为支撑，薄板面朝前方并搭配 Brandy 色的亮光漆面，让沙发看起来十分轻盈，同时也丰富其美学内涵，让人想起行李箱和手提箱的金属部件。

As well as the fabric covering, the padded structural base can also feature a covering with strips of leather, crafted with the same technique used in fine leather luggage-crafting. References to the concept of high-end leather goods are also found in the headrests and the elegant “C”-shaped Flap surfaces, which seamlessly blend into the seating elements, animating the compositions with a vibrant rhythm.









模块化沙发的沙发组合，大尺寸的大理石茶几组合和极富线条感的扶手椅是日间区域的亮点。这些产品虽然由不同的设计师打造而成，但却是出乎意料的在场景中达到了完美的融合。



扶手椅秉承传统设计理念，用充满现代感的方式重新诠释它的线条和比例，在设计与经典之间达到完美平衡。传统元素特别体现在室内配件的制作工艺上，在座椅中运用弹簧来增加弹性。表面的剪裁加工也体现出高超的工艺水平，以此为基础，这款扶手椅拥有不随时间流转的永恒魅力。

添加填充物的基座和上方坐垫之间的分隔线展现出高超的缝制工艺，代表着公司在剪裁领域的非凡功力。



## INSPIRATION AND CREATIVITY

不同的灵感和创意始终贯穿其中

生动的形状、鲜活的纹理、大胆的风格 创造自己眼中的舒适与和谐

在专属的秩序之中纵享生活之美

Different inspirations and ideas always transition into it Bright shape,  
vivid texture, bold style Create comfort and harmony in your own eyes  
Indulge in the beauty of life in an exclusive hierarchy

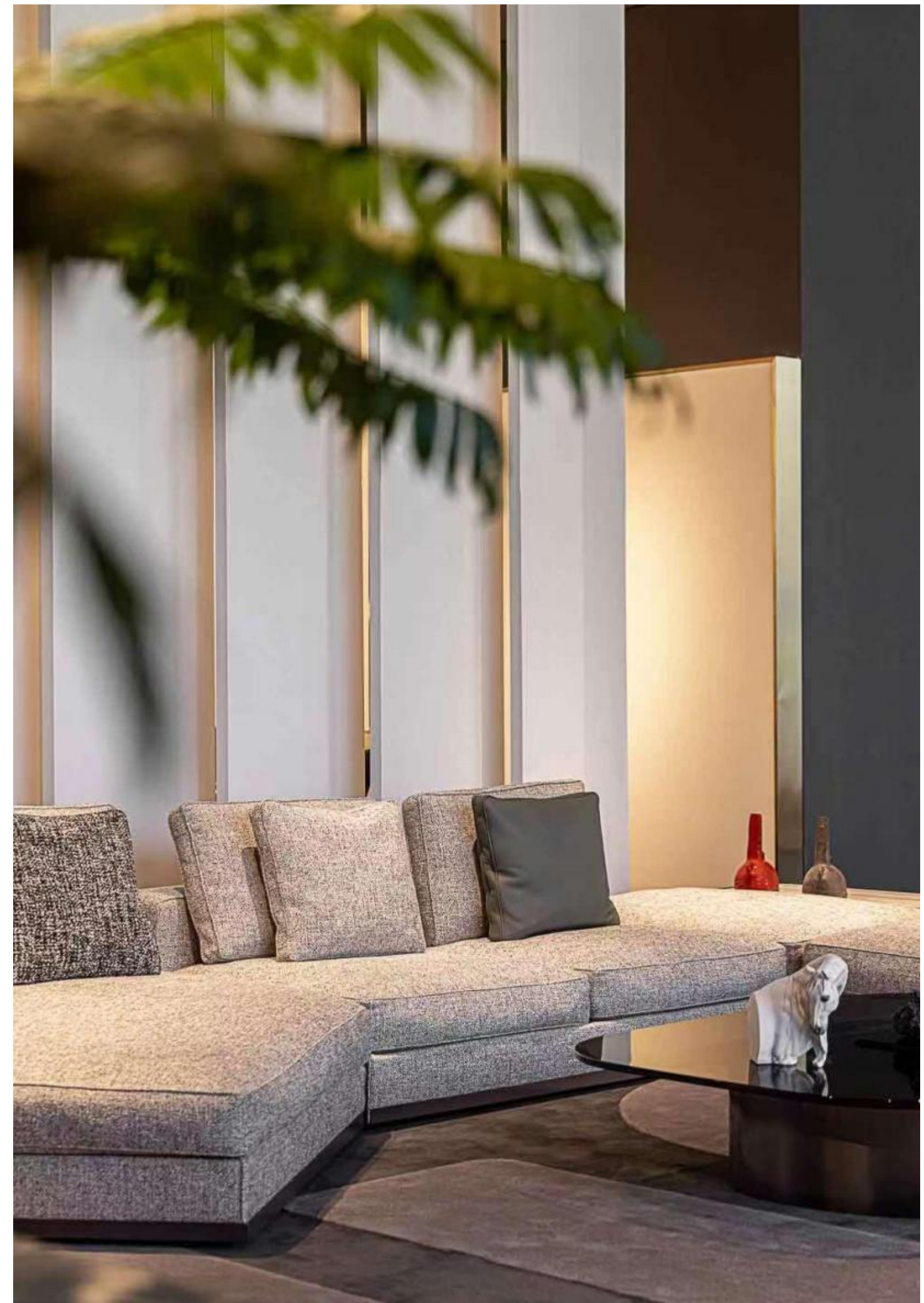



FITTED











## LIFE OF CITY

在喧闹的都市丛林中  
FITTED用自己的作品为你的家  
中辟出一方天地让你可以静静  
徜徉在地中海的浪漫气息中

In the noisy urban jungle  
FITTED uses its own work to create a space  
for your home Let you wander quietly  
in the romantic atmosphere of the  
Mediterranean



软垫结构基座，除了选择织物覆面以外，还可以选择皮革覆面，这一覆面采用箱包工艺制作而成。高端皮具的理念亦体现在头枕和优雅的“C”形 Flap 隔板上，两者可以和谐地融入到座椅元素中，为组合形式注入生动的节奏。结构基座采用挤压铝型材制成的薄板作为支撑，薄板面朝前方并搭配 Brandy 色的亮光漆面，让沙发看起来十分轻盈，同时也丰富其美学内涵，让人想起行李箱和手提箱的金属部件。



As well as the fabric covering, the padded structural base can also feature a covering with strips of leather, crafted with the same technique used in fine leather luggage-crafting. References to the concept of high-end leather goods are also found in the head rests and the elegant “C”-shaped Flap surfaces, which seamlessly blend into the seating elements, animating the compositions with a vibrant rhythm.



## FITTED

FITTED 的关键特质在于全方位地诠释 “意大利制造” 的概念，如今，传统和创新完美融合其中。多年来，FITTED 始终在产品系列中呈现自身特有的格调并不断加以发展，遵循在传承中创新的指导原则。永恒的优雅、传统的延续、精湛的工艺、细节之处的一丝不苟，这些特质源自 FITTED 的 DNA，与洗练的美学价值理念结合在一起。

Over the years the company has conceived a specific “Minotti code”, that has become a constant feature of every collection, always following the key principle of “innovation in the spirit of continuity”. Deeply rooted in the company's DNA, it is linked to the principles of aesthetic understatement, timeless elegance, continuity in the sign of tradition, artisan savoir-faire with great attention to sartorial details.





# 丹尼尔斯

双偏移单元

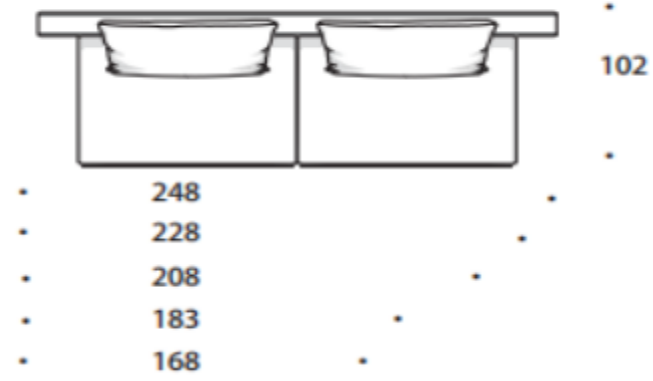

偏移单元

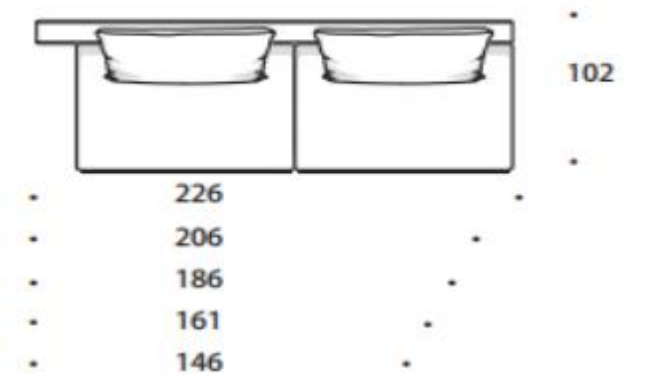

转角沙发

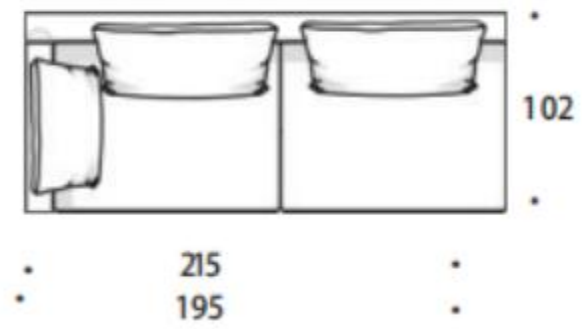

单贵妃沙发

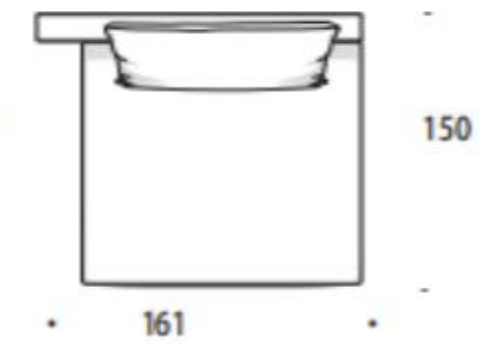

双偏移贵妃沙发

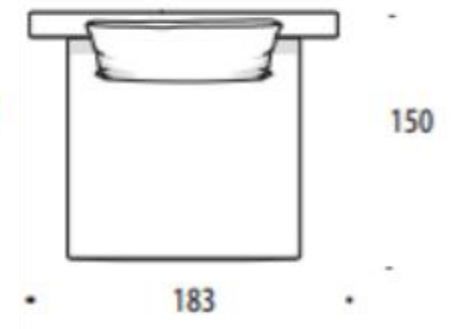

偏移转角单元

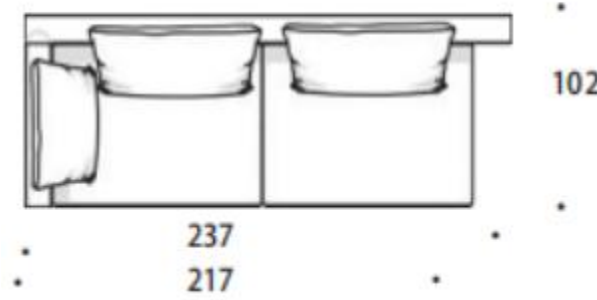

中央单元

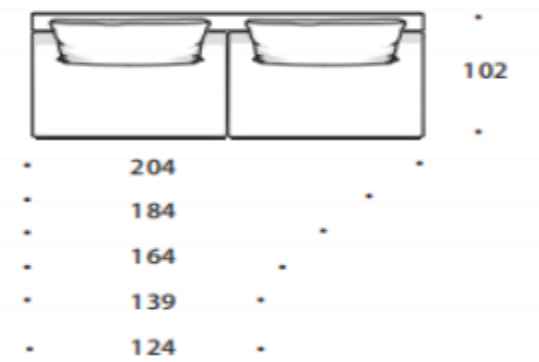

带磁铁的软凳

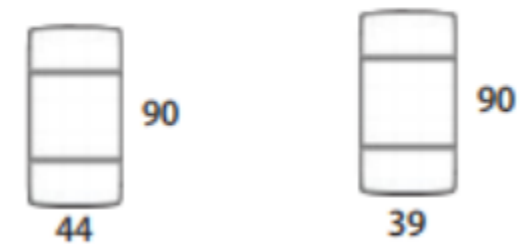

可选靠背垫

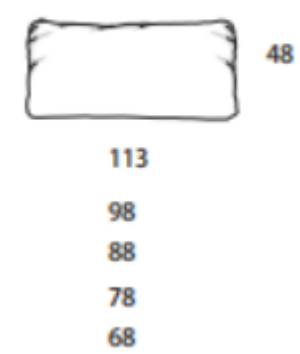

可选靠垫





劳森



罗素

大敞口圆沙发单元 (左右)

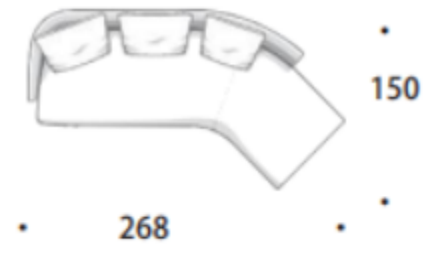

大敞开半圆单元 (左右)

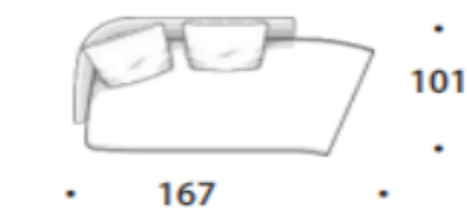

大半圆单元 (左右)



大敞开半圆单元 (左右)

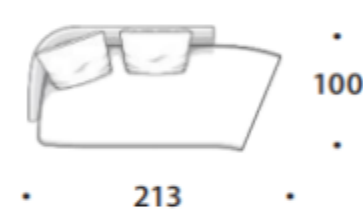

宽敞沙发椅单元 (左右)

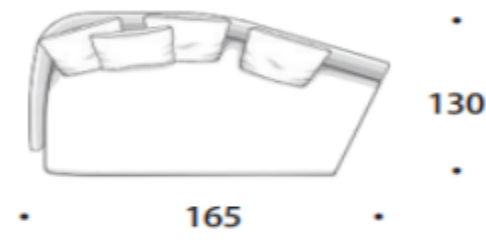

大半圆单元 (左右)

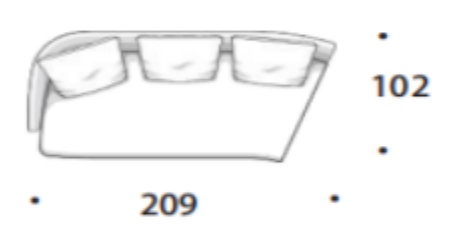

可选靠垫

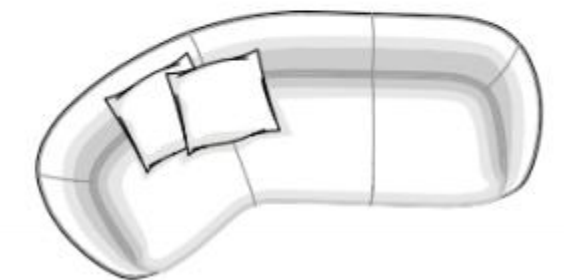
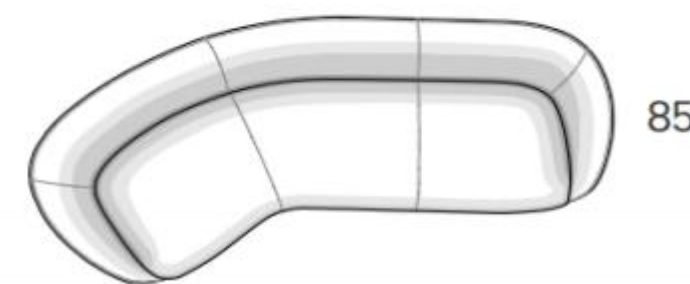
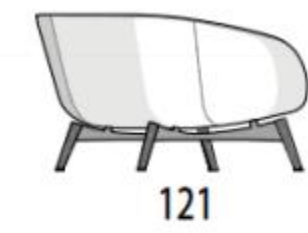
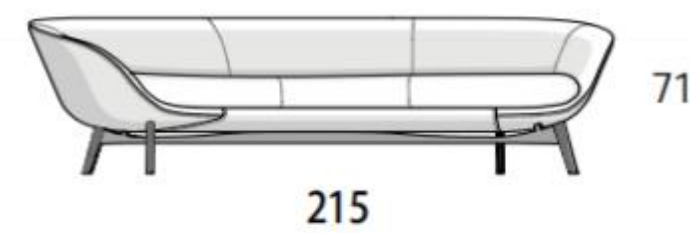



# 自由人

双扶手单元



一个扶手单元

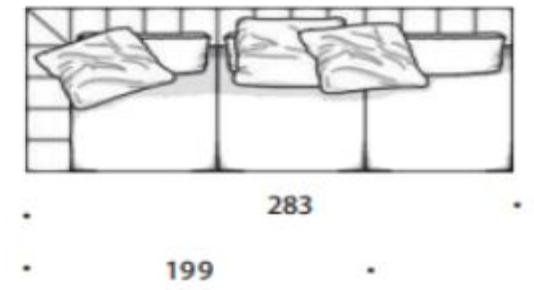

躺椅

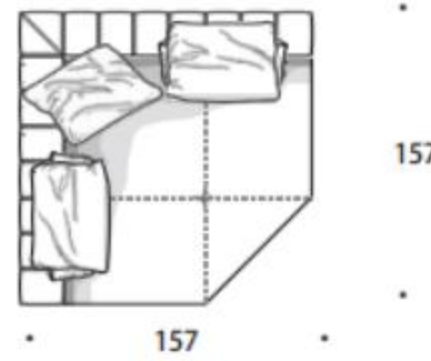

中央单元

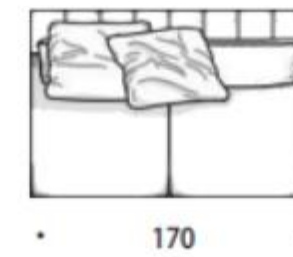

转角单元

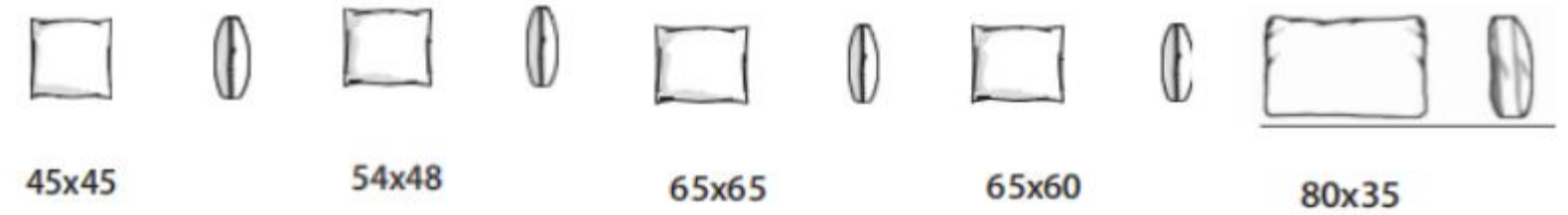
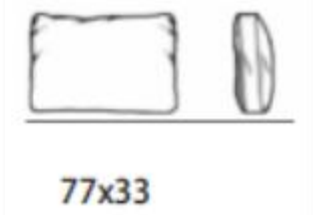

含一个扶手单元

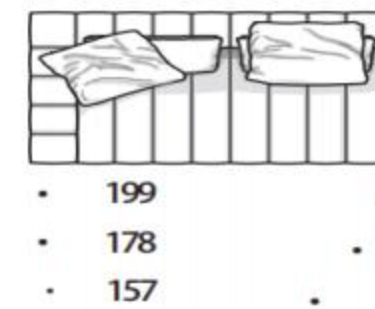

中央单元

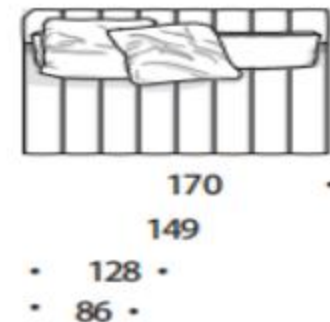

一个扶手单元

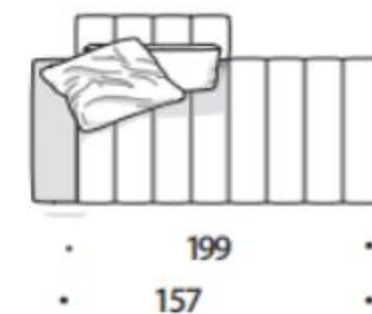

开放结束单元-靠背84cm

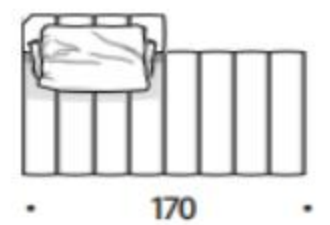

躺椅

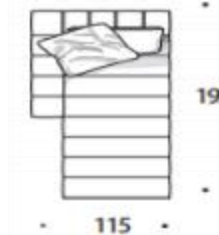

躺椅

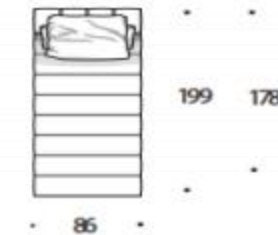

躺床

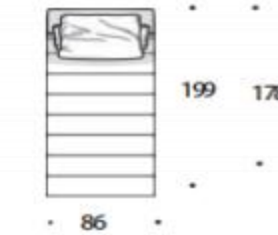

一个扶手单元

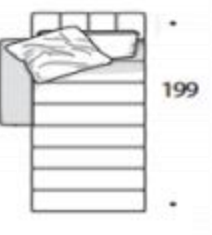

开放结束单元含扶手

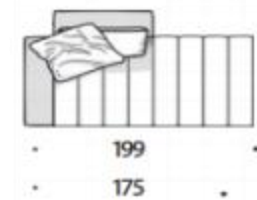

开放结束单元

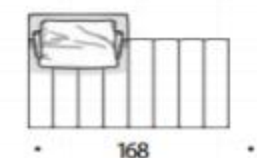

一个扶手单元

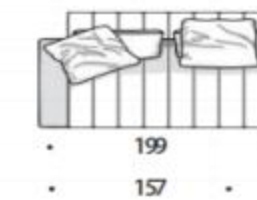

一个扶手单元

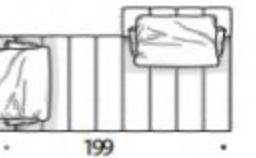



# 西方

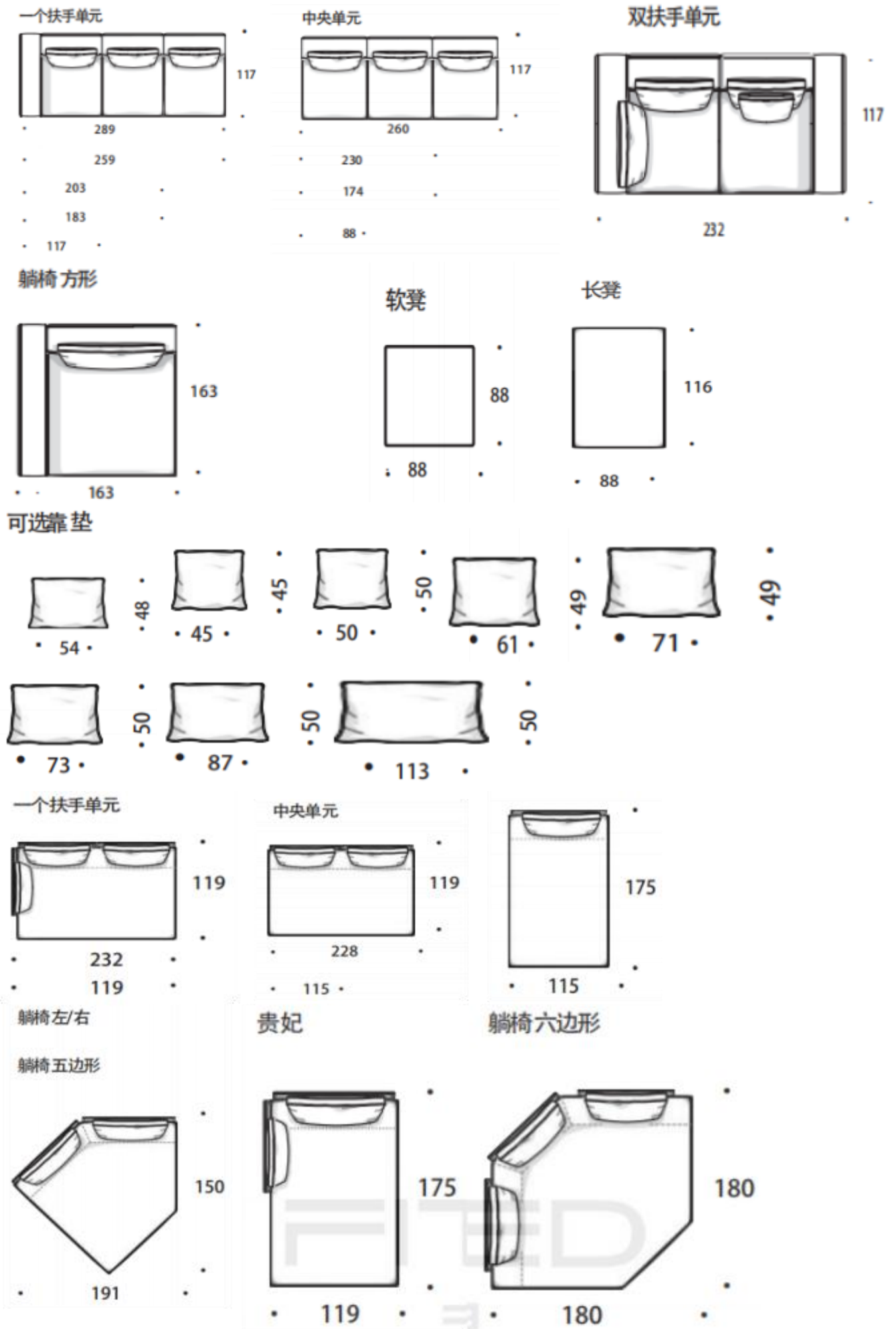



托里

矮背沙发CM294

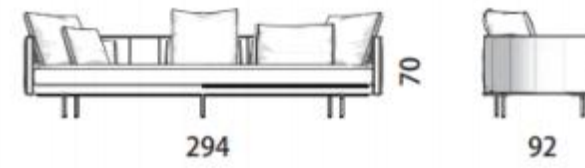

矮背沙发CM246

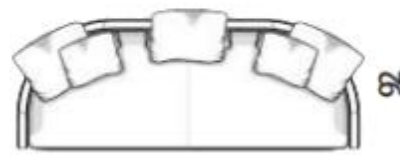
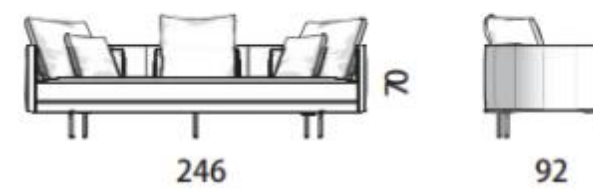

矮背沙发CM174

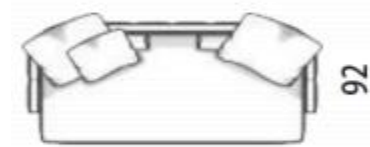

半圆形坐垫



矮背斜面沙发CM240

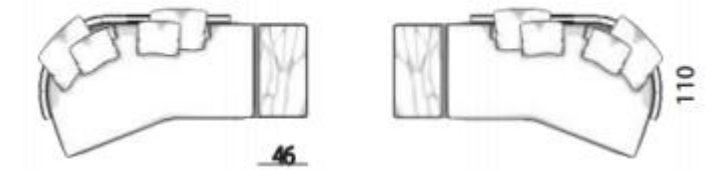
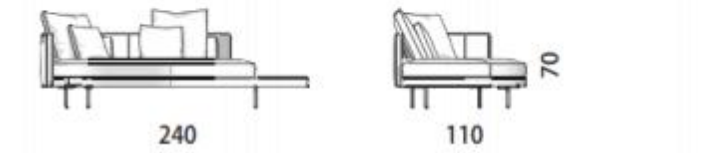

矮背沙发CM196

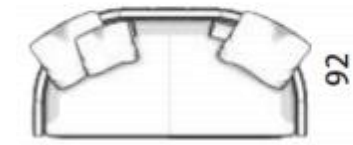

矮背沙发CM270

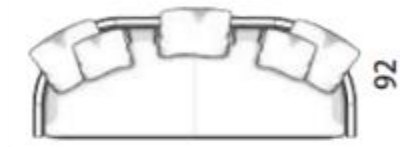

抱枕





康纳利

沙发带侧翼CM224

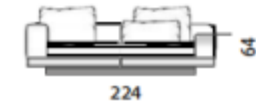

沙发带侧翼 CM 304

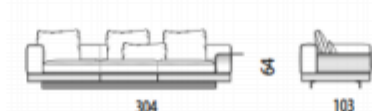

双扶手单元CM261



沙发带靠背侧翼CM291

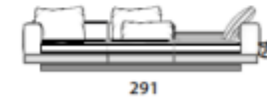

双扶手沙发CM291

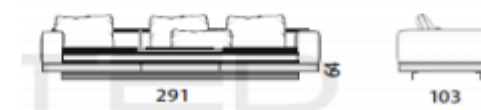

带1个扶手的单元CM146

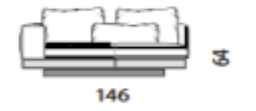

带1个扶手的单元CM166

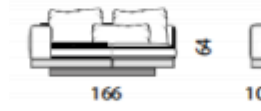

带1个扶手的单元CM186



单扶手单元CM236

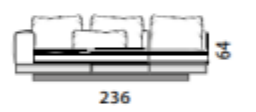

带1个扶手的单元CM265

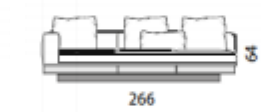

沙发带侧翼CM166



沙发带侧翼CM186

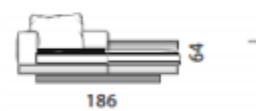

单扶手靠背带侧翼单元CM236

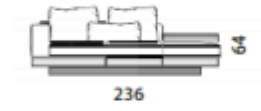

沙发带侧翼CM266



带侧翼双扶手单元CM159

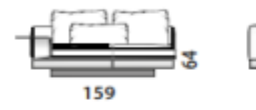

带侧翼扶手单元CM199

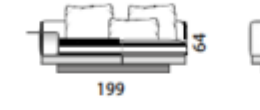

带侧翼扶手单元CM249

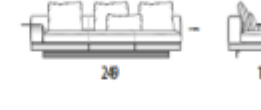

单扶手靠背单元CM166X103

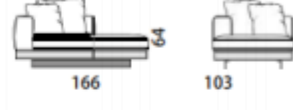

带1个扶手的单元CM265X103



无扶手单元CM161



无扶手单元CM241



无扶手靠背带侧翼单元CM 141

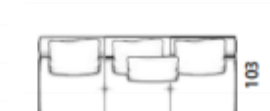
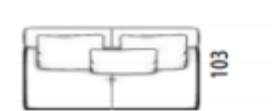



# 康纳利

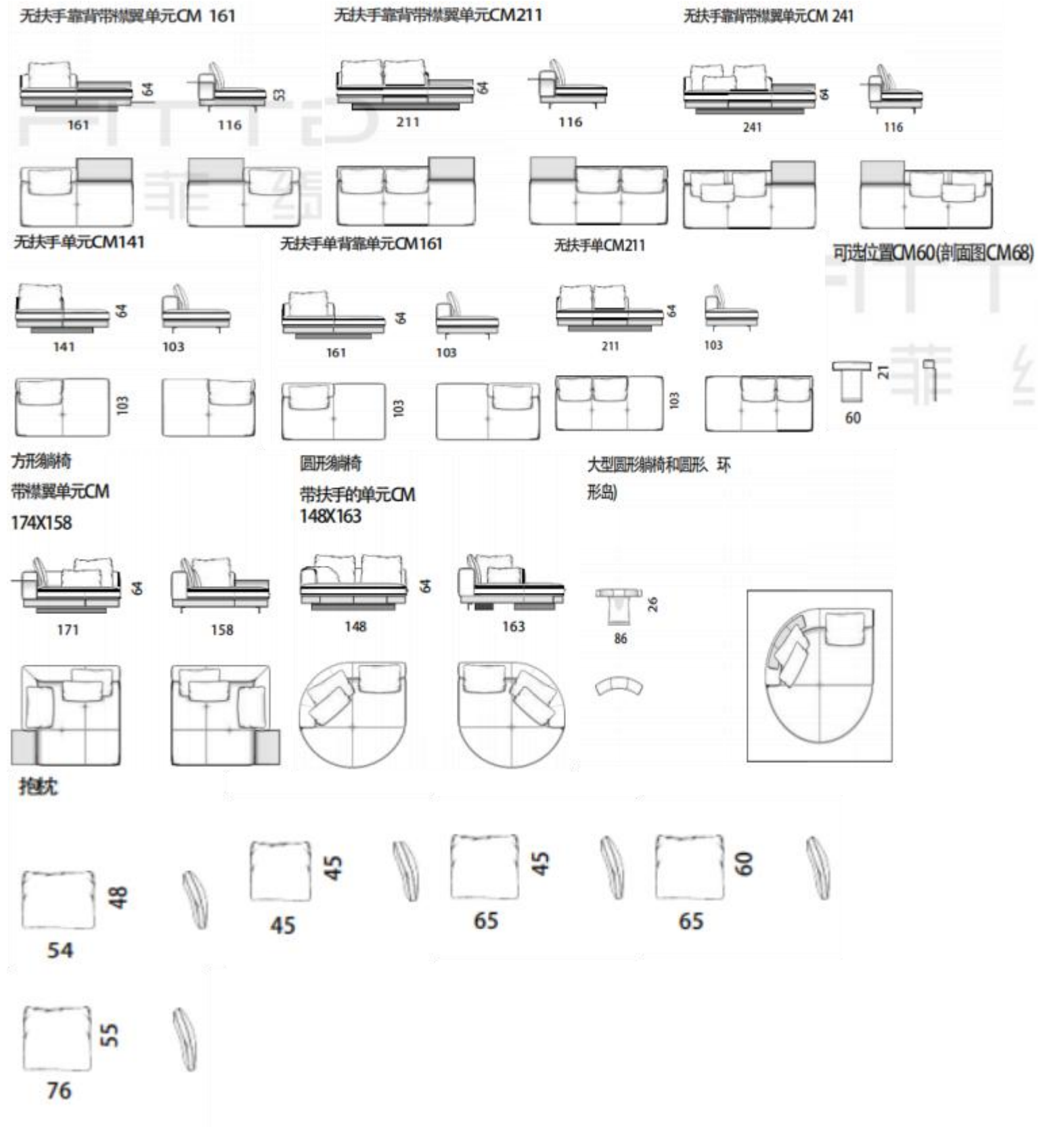



布莱泽

沙发

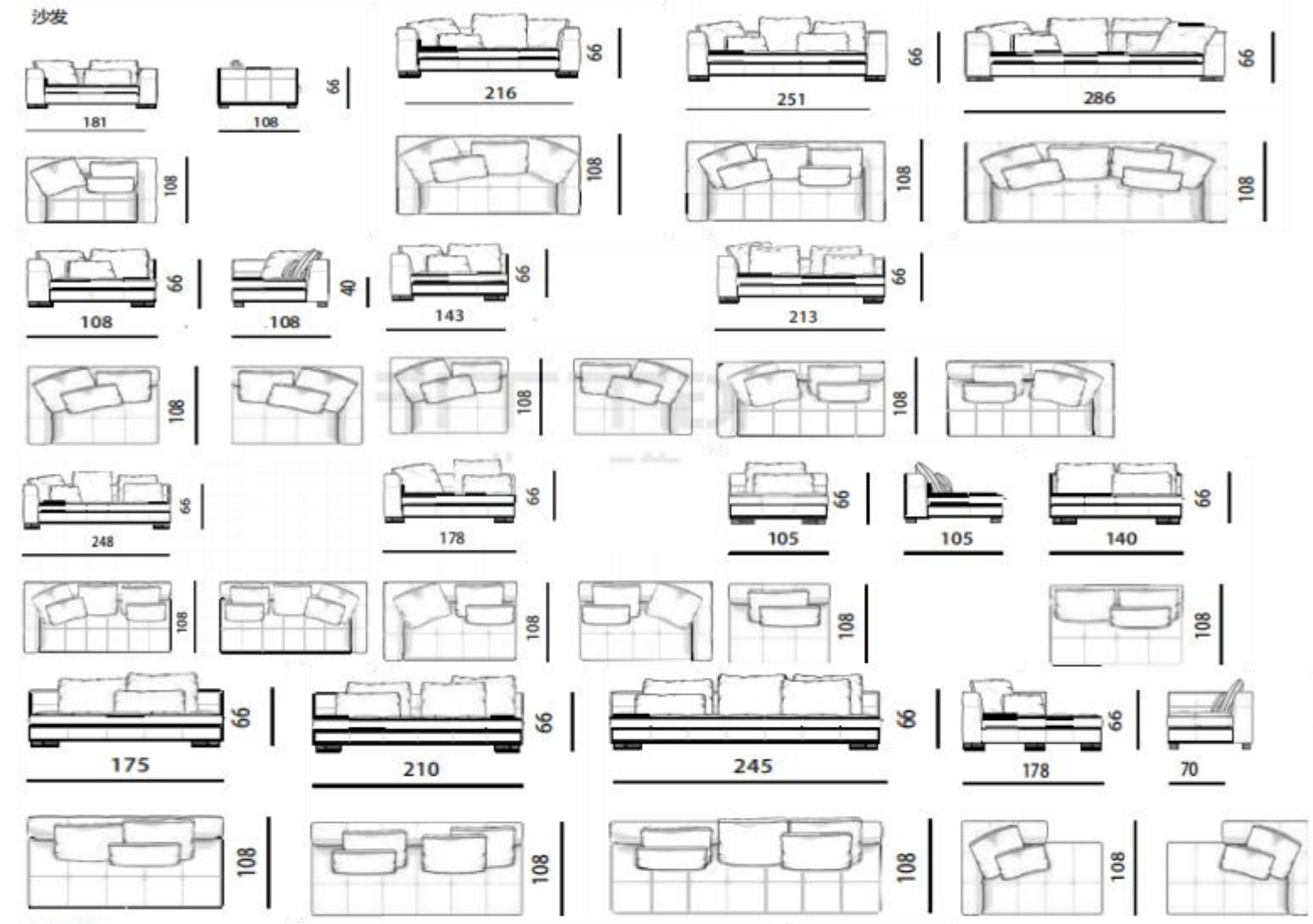

143X143

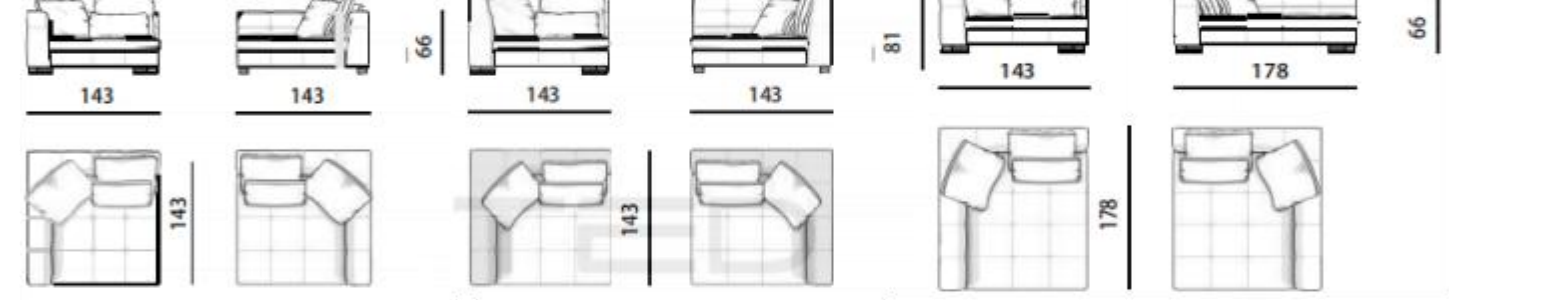

方榻

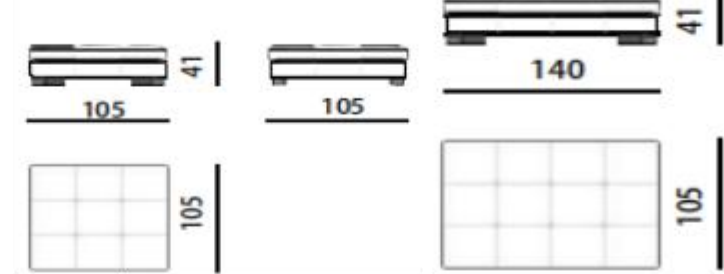

可选抱枕

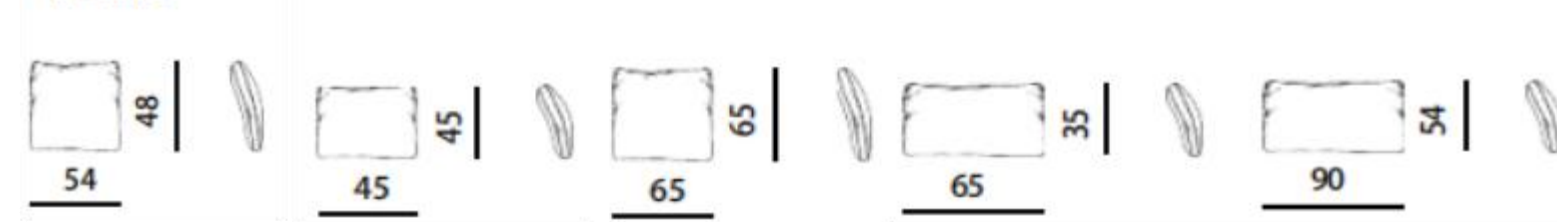



劳伦斯

一个扶手单元cm86-高扶手



一个扶手单元cm80-高扶手

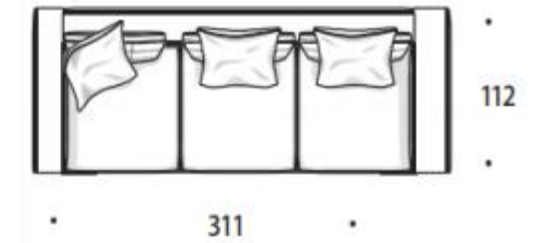

中央单元cm86

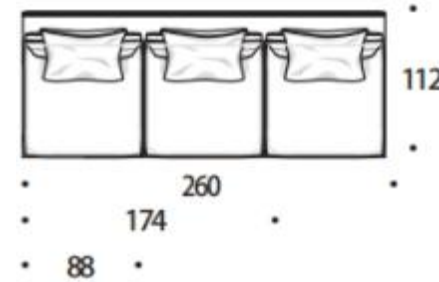

中央单元cm80

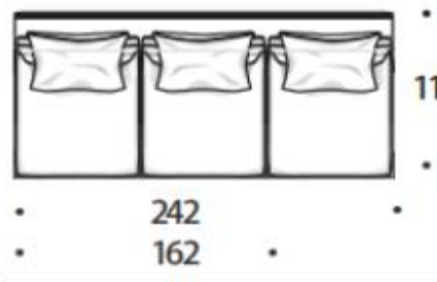

软凳

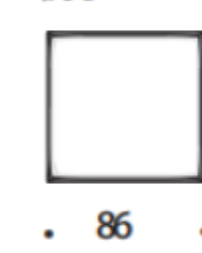

软凳

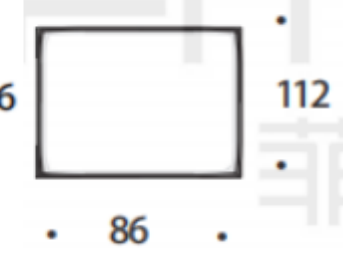

170x112

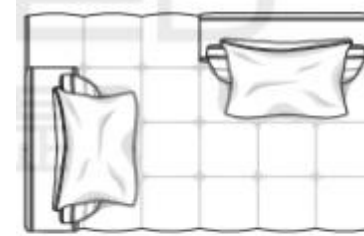

170x168

靠背112 cm和84 cm

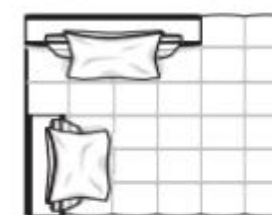

114x112

靠背单元84 cm



140x112

靠背单元84 cm

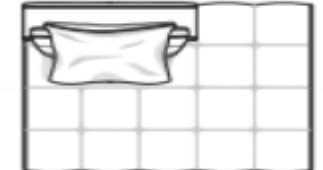

170x112



深度112cm

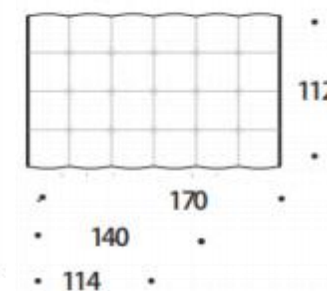

可选背靠枕

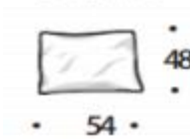

可选背靠枕

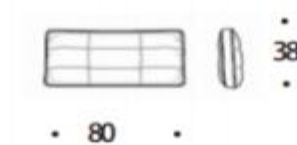
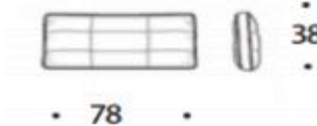
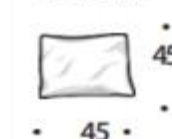



# 罗杰

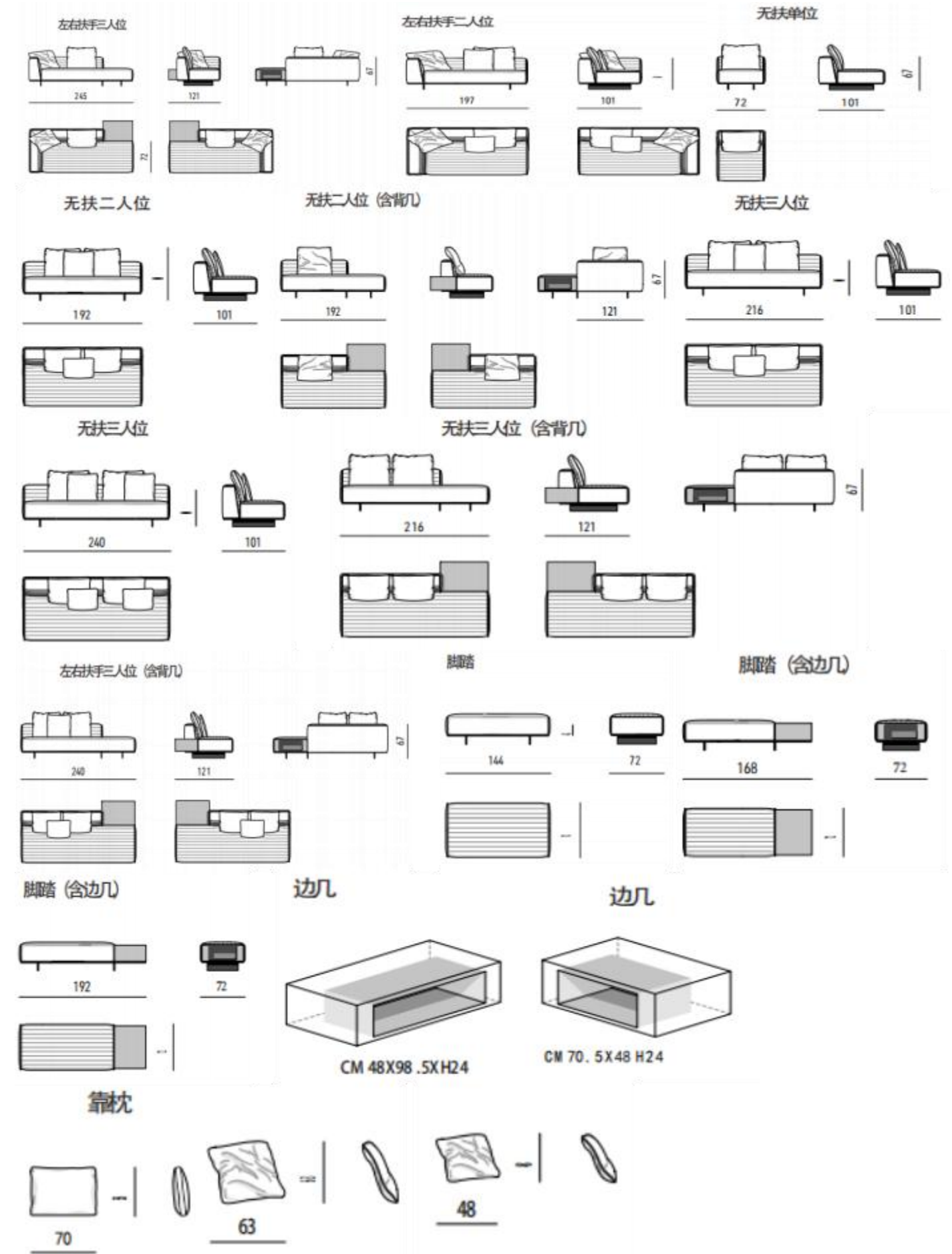



罗杰

三位沙发 cm 183x83



单人位 cm 93x83



茶几类



柏丽  
 Ø35x45H (cm)  
 Ø52x29H (cm)  
 Ø102x28H (cm)



博登  
 Ø38x51H (cm)  
 Ø70x36H (cm)



卢  
 61Wx45Dx53H (cm)



雅各布  
 130Wx120Dx29.5H (cm)  
 148Wx85Dx28.5H (cm)  
 Ø110x29H (cm)



侧边  
 46Wx46Dx45H (cm)  
 121Wx121Dx26H (cm)



艾龙  
 38Wx38Dx43H (cm)



米尔顿  
 119.5Wx119.5Dx30H (cm)



琥珀  
 43Wx86Dx36H (cm)  
 83Wx83Dx45H (cm)  
 110Wx83.5Dx36H (cm)  
 226.8Wx100Dx32H (cm)



歌曲  
 148Wx105Dx38H (cm)



奥利弗  
 Ø46x48H (cm)



克莱夫  
 110Wx45Dx38H (cm)  
 140Wx45Dx60H (cm)  
 160Wx55Dx60H (cm)



考尔德  
 140Wx35Dx53H (cm)



手柄  
 120Wx120Dx30H (cm)



楔子  
 170Wx90Dx33H (cm)



马蒂亚  
 159.5Wx99Dx29.5H (cm)



手镯  
 Ø130x35.5H (cm)  
 140x110x35.5H (cm)



楔子  
 Ø134.5x29H (cm)  
 Ø120x30H (cm)



塞萨  
 Ø36x45H (cm)



安妮施  
 Ø50x41H (cm)



杜尚  
 Ø48x51H (cm)



授权  
 Ø45x49H (cm)  
 Ø45x38H (cm)



调情  
 37Wx30Dx42H (cm)



里特  
 86Wx86Dx18.5H (cm)



挡板  
 48Wx40Dx36H (cm)  
 143Wx120Dx25H (cm)



编码  
 72x56x43.5H (cm)

休闲类



谢利  
85Wx80Dx70H (cm)



安格  
85Wx88Dx92H (cm)



芬恩  
80Wx93Dx82H (cm)



德劳耐-2  
80Wx80Dx80H (cm)



行李箱  
76Wx84Dx63H (cm)



罗素  
81Wx80Dx68H (cm)



托里  
90Wx90Dx84H (cm)



温斯顿  
74Wx85Dx72H (cm)



芬恩  
82Wx96Dx79H (cm)



华莱士  
78Wx91Dx73H (cm)



格洛韦尔  
97Wx78Dx78H (cm)  
62Wx47Dx44H (cm)



里维斯  
75Wx78Dx71H (cm)

餐台类



楔子  
180Wx110Dx75.5H (cm)  
220Wx110Dx75.5H (cm)  
260Wx110Dx75.5H (cm)  
直径156x75.5H (cm)  
直径180x75.5H (cm)



楔子 (玻璃)  
240Wx110Dx74H (cm)  
200Wx110Dx74H (cm)  
直径180x180x74H (cm)  
直径140x140x74H (cm)



楔子  
240Wx110Dx74H (cm)



塞罗  
180Wx105Dx76.5H (cm)  
220Wx105Dx76.5H (cm)  
240Wx105Dx76.5H (cm)



林哈  
200Wx115Dx74H (cm)  
240Wx115Dx74H (cm)  
280Wx115Dx74H (cm)



卢 (石材)  
直径140xx76H (cm)  
直径160xx76H (cm)  
直径180xx76H (cm)



卡森  
180Wx60Dx73H (cm)  
220Wx90Dx73H (cm)



奥利弗  
直径110xx66H (cm)

餐椅类



安格  
65Wx60Dx81H (cm)



劳森 (无扶手)  
60Wx55Dx82H (cm)



劳森 (有扶手)  
60Wx60Dx82H (cm)



芬恩  
66Wx60Dx85H (cm)



西雅图  
带扶手55.5Wx56.5Dx80H (cm)  
不带扶手56Wx54Dx80H (cm)



商业  
47Wx47Dx96H (cm)  
47Wx47Dx85H (cm)



里维斯  
56Wx56Dx79H (cm)



弗诺瑞  
55Wx60Dx78H (cm)

床类



塔特林  
150Wx200D (cm)  
180Wx200D (cm)



杰奎琳  
150Wx200D (cm)  
180Wx200D (cm)



然达  
180Wx200D (cm)  
200Wx220D (cm)



劳伦斯  
180Wx200D (cm)  
200Wx220D (cm)



塔特盖  
150Wx200D (cm)  
180Wx200D (cm)  
200Wx220D (cm)



西本斯  
150Wx200D (cm)  
180Wx200D (cm)



柯蒂斯  
150Wx200D (cm)  
180Wx200D (cm)

床头柜



造梦者  
50Wx46Dx50H(cm)  
75Wx46Dx50H(cm)



米尔顿  
55Wx55Dx50H (cm)  
75Wx55Dx45H (cm)



启本珂  
50Wx45Dx43H (cm)  
75Wx45Dx43H (cm)



卢  
55Wx50Dx43H (cm)  
75Wx45Dx43H (cm)



戴尔  
72Wx43.9Dx42H (cm)  
90Wx43.9Dx42H (cm)

功能柜



卢  
199.5Wx55Dx71.5H (cm)



启本珂  
225Wx55Dx68H (cm)



卡森  
173Wx58Dx147H (cm)



造梦者  
186Wx56Dx66H (cm)  
240Wx56Dx66H (cm)



造梦者  
120Wx56Dx120H (cm)  
120Wx56Dx84H (cm)



戴伦  
186Wx56Dx89H (cm)

塌类



昆西  
143Wx54Dx36H (cm)



克莱夫  
135Wx45Dx45H (cm)



西方  
62Wx62Dx38H (cm)



罗卡  
65Wx65Dx32H (cm)



自由人  
135Wx47Dx37H (cm)



托里  
70Wx70Dx40H (cm)



安格  
64Wx54Dx38H (cm)



雪纳  
84Wx84Dx35H (cm)  
直径82x35H (cm)