

单页尺寸: 170*250

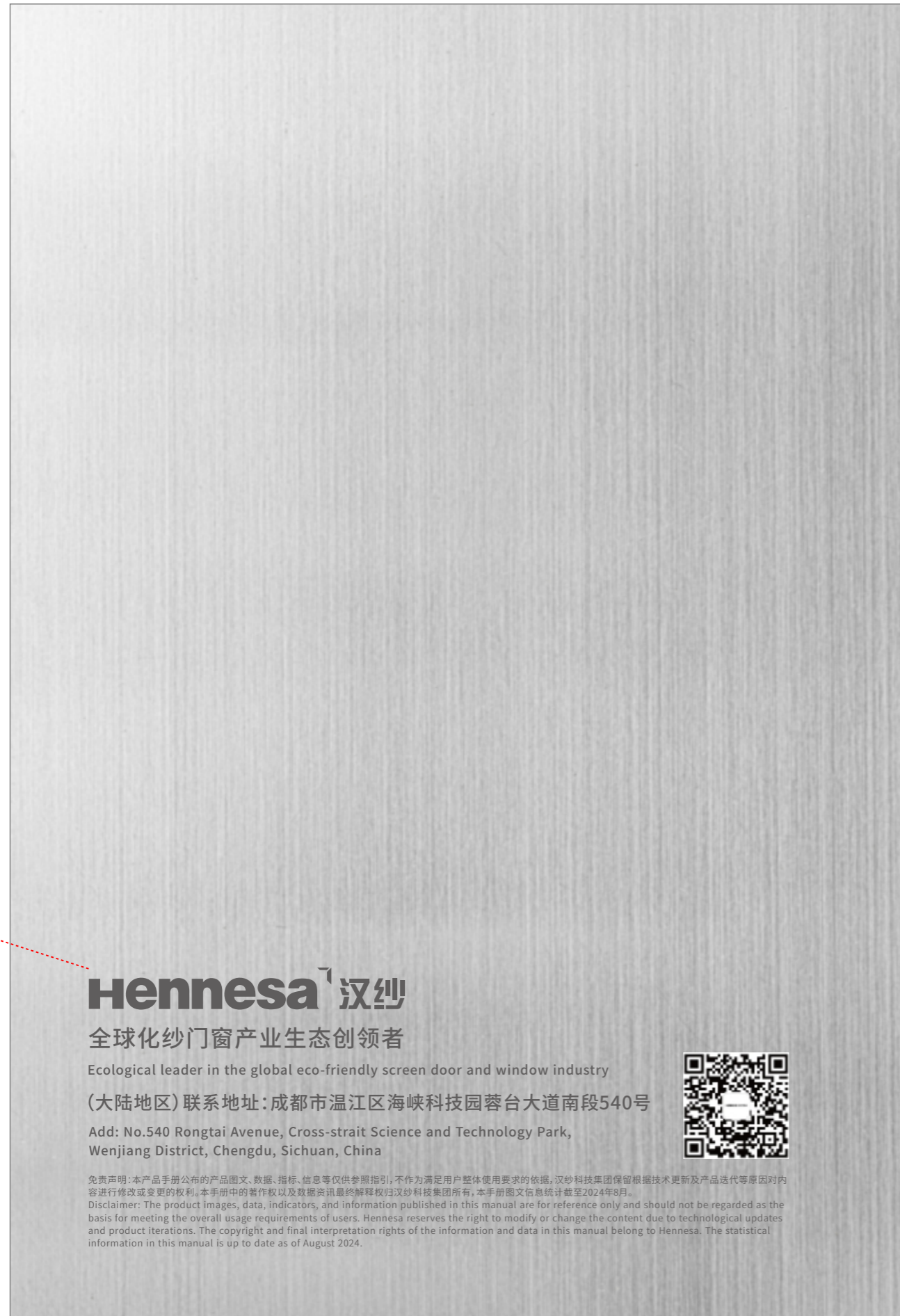

压凹

Hennesa¹ 汉纱

全球化纱门窗产业生态创领者

Ecological leader in the global eco-friendly screen door and window industry

(大陆地区) 联系地址: 成都市温江区海峡科技园蓉台大道南段540号

Add: No.540 Rongtai Avenue, Cross-strait Science and Technology Park,
Wenjiang District, Chengdu, Sichuan, China



免责声明: 本产品手册公布的产品图文、数据、指标、信息等仅供参考指引, 不作为满足用户整体使用要求的依据, 汉纱科技集团保留根据技术更新及产品迭代等原因对内容进行修改或变更的权利。本手册中的著作权以及数据资讯最终解释权归汉纱科技集团所有, 本手册图文信息统计截至2024年8月。
Disclaimer: The product images, data, indicators, and information published in this manual are for reference only and should not be regarded as the basis for meeting the overall usage requirements of users. Hennesa reserves the right to modify or change the content due to technological updates and product iterations. The copyright and final interpretation rights of the information and data in this manual belong to Hennesa. The statistical information in this manual is up to date as of August 2024.

单页尺寸: 170*250



“宇宙”
哑银255g
双层,
+覆膜

凹版压痕

凹版压痕

Hennesa Product

产品指南
PRODUCT GUIDE

Hennesa¹ 汉纱

单页尺寸: 170*250



Hennesa 汉纱

全球化纱门窗产业生态创领者

Ecological leader in the global eco-friendly screen door and window industry

无距自然
纵横科技

hennesa

DISTANCE FREE NATURAL
VERTICAL AND HORIZONTAL TECHNOLOGY

产品目录 Catalog

无轨纱门
Trackless Screen Door

H1-无轨纱门
H1 Trackless Screen Door

H1Z-智能无轨纱门
H1Z Electric Intelligent Trackless Screen Door

H8-无障碍纱门
H8 Trackless Screen Door

折叠纱门
Folding Screen Door

H6-双向联动折叠纱门
H6 Bi-directional Sliding Screen Door

回卷纱门窗
Retractable Screen Window and Door

H2-回卷隐形纱门窗
H2 Retractable Invisible Screen Window and Door

H2Z-电动回卷纱窗
H2Z Electric Intelligent Retractable Invisible Screen Window

H5-TITATITA回卷纱窗
H5 TITATITA Retractable Invisible Screen Window

平移纱门
Sliding Screen Door

H9-全景平移纱门
H9 Soft-closing Sliding Screen Door

H12-极窄无轨平移纱门
H12 Ultra-narrow Trackless Sliding Screen Door

H12Z-智能极窄平移纱门
H12Z Electric Intelligent Ultra-narrow Sliding Screen Door

平开纱窗
Casement Screen Window

H22-滑盖小平开
H22 Sliding Cover Casement Screen Window

全球选材
Global Selection

型材网材精选
Global Profiles, Mesh Selection

H1 无轨纱门 H1 Trackless Screen Door



产品特色 product characteristic

非折叠平面网+坦克链 融合创新设计
Non-foldable flat mesh + Tank Chain Integrated Innovative Design

无坦克链条隐藏式设计, 搭配高透平网, 更简洁美观。
Tankless chain hidden design with high translucent mesh, more simple and beautiful.

悬浮无轨门 通行无阻

Floating trackless door with unobstructed access

真正无底轨, 美观易清洁, 实现无障碍通行, 适配所有门型。
Real trackless, beautiful and easy to clean, realize barrier-free access, suitable for all door types.

创新科技平网 高清高透

Innovative technology flat mesh High-definition and high-transparency

视野清晰通透, 意大利进口定制设备专业热熔封边, 网面均匀受力不褶皱, 美观更耐用。
Clear and transparent vision, professional hot melt sealing edge with Italy imported customized equipment, the mesh surface uniform force does not wrinkle, beautiful and more durable.

产品参数 product information

适配网材 Screen Mesh	美国飞佛网 America Phifer
开合方式 Opening Method	单拉、对碰 Single, Double
尺寸范围 Size Range	单拉: MIN:W:396xH:600 (single) MAX: W:1750xH:2800 对碰: MIN:W:792xH:600 (double) MAX: W:3500xH:2800
框体颜色 Profile Color	星际黑丝 Metal Brushed Black 铂灰丝 Metal Brushed Platinum Gold 星空灰丝 Metal Brushed Grey 月光灰丝 Metal Brushed Light Grey 星河咖 Smooth Brown 哑光金属灰 Matt Grey 哑光白 Matt White
适用门型 Application	平开门、推拉门、折叠门、内开门 Casement Doors, Sliding Doors, Folding Doors, Inward-opening Doors

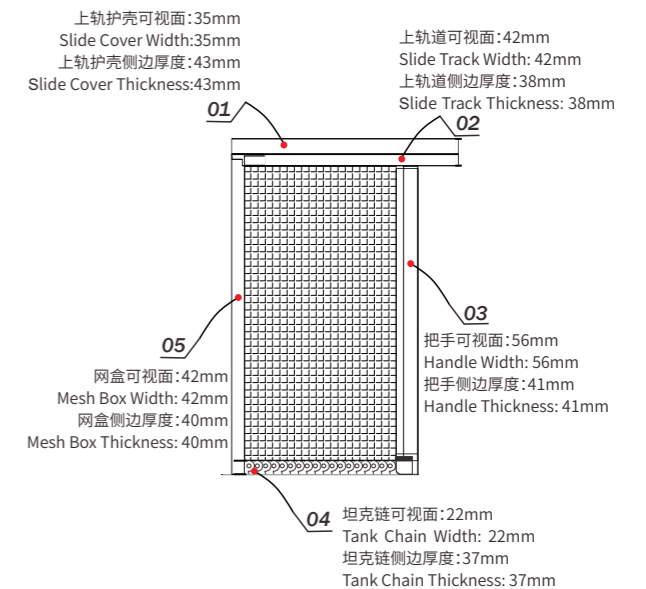

H1z 智能无轨纱门

H1z Electric Intelligent Trackless Screen Door



产品特色 product characteristic

智能无轨侧开 操控随心

Intelligent trackless side opening for easy control

标配手机智控、微波感应控制,有停电手动及遇阻防夹功能,便捷安全。

Standard equipped with cell phone intelligent control and microwave sensor control In case of power failure, there are manual and anti-clamping functions, convenient and safe.

FOC矢量算法 敏捷响应

FOC vector algorithm Agile Response

自动驾驶、精密仪器同款FOC矢量控制算法,系统开合响应在0.2秒以内。

Same FOC vector control algorithm for autopilot and precision instruments, system open/close response within 0.2 seconds.

家居互联 尽在“掌握”

Home connectivity in the palm of your hand

可实现全屋智能家居联动,弹指之间,掌控自在生活。

Realize whole-house intelligent home linkage, control your life at your fingertips.

产品参数 product information

适配网材 Screen Mesh	高定玻纤网 High-end Customized Fiberglass Mesh
开合方式 Opening Method	单拉、对碰 Single、Double
尺寸范围 Size Range	单拉 (single): MAX: W:2000xH:2800 对碰 (double): MAX: W:4000xH:2800
框体颜色 Profile Color	星际黑丝 Metal Brushed Black
适用门型 Application	平开门、推拉门、折叠门、内开门 Casement Doors, Sliding Doors, Folding Doors, Inward-opening Doors

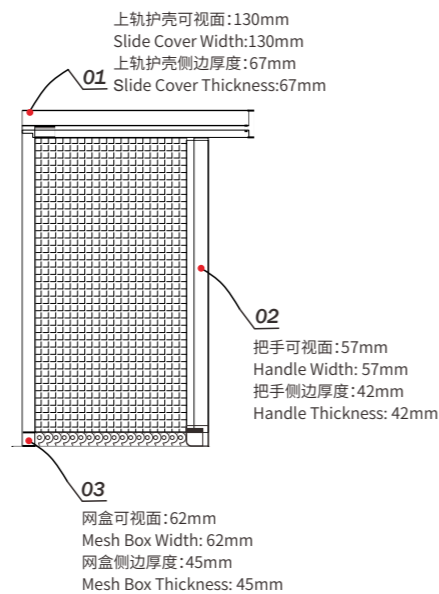

H8 无障碍纱门

H8 Trackless Screen Door



产品特色 product characteristic

超低底轨设计 通行无障碍

Ultra-low bottom track design for barrier-free access

仅5毫米超低轨坦克链条,进出通行无阻,不易积灰。

With only 5mm ultra-low track tank chain, Allowing Smooth Entry and Exit, Resistant to Dust Accumulation.

快装结构 拆装便捷

Quick-install structure for easy assembly and disassembly

通过码扣固定,安装简单,可快速拆卸,方便清洗。

Fixed by fasteners, it is easy to install, quick to disassemble, and convenient to clean.

产品参数 product information

适配网材 Screen Mesh	卷帘专用网 Roller Shutter Special Mesh
开合方式 Opening Method	左右拉 Sliding
尺寸范围 Size Range	MIN:W:396xH:600 单拉 (single): MAX: W:1730xH:2600 对碰 (double): MAX: W:3460xH:2600
框体颜色 Profile Color	哑光金属棕 Matt Brown 哑光金属灰 Matt Grey
适用门型 Application	平开门、推拉门、折叠门、内开门 Casement Doors, Sliding Doors, Folding Doors, Inward-opening Doors

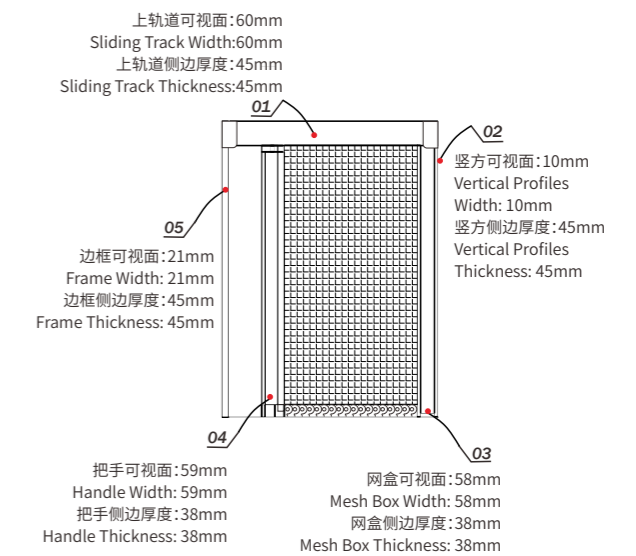

H9 全景平移纱门

H9 Soft-closing Sliding Screen Door



产品特色 product characteristic

高清阔尺平网 视野无遮挡

HD wide-foot flat screen with unobstructed views

高清高透平网, 单扇尺寸可达2.6米, 无腰线遮挡, 视野更通透宽广。HD and high-transmission flat mesh, single mesh size up to 2.6 meters, no waistline blocking, more transparent and wide field of vision.

丝滑低轨 简洁美观

Silent low track Simple and beautiful

13毫米不锈钢低轨, 推拉顺滑, 美观易清洁。13mm stainless steel low track, push and pull smoothly, beautiful and easy to clean.

缓冲启闭 静音耐用

Soft opening and closing Quiet and durable

升级缓冲设计, 闭合静音, 稳定防撞, 更安全耐用。Upgraded buffer design, closed quietly, stable anti-collision, safer and more durable.

产品参数 product information

适配网材 Screen Mesh	格特网 Security Mesh 电纳磁11# 11# Flexible Security Mesh 电纳磁25# 25# Flexible Security Mesh 电循磁网 Electrophoretic Coating Security Mesh
开合方式 Opening Method	单轨单扇 Single Track Single Mesh 单轨双扇 Single Track Double Meshes 双轨四扇 Double Tracks Double Meshes 双轨双扇 Double Tracks Four Meshes
尺寸范围 Size Range	单拉 (single): MAX: W:2400xH:3000 对碰 (double): MAX: W:4800xH:3000 (网材不同, 最大极限尺寸有差异) The max limiting size varies depending on the mesh material
框体颜色 Profile Color	星际黑丝 Metal Brushed Black 星空灰丝 Metal Brushed Grey 灰砂纹 Gray Sand Color 棕砂纹 Brown Sand Color
适用门型 Application	推拉门、平移门、内倾侧滑门 Sliding Doors, Horizontal Sliding Doors, Inward Tilting Side Sliding Doors

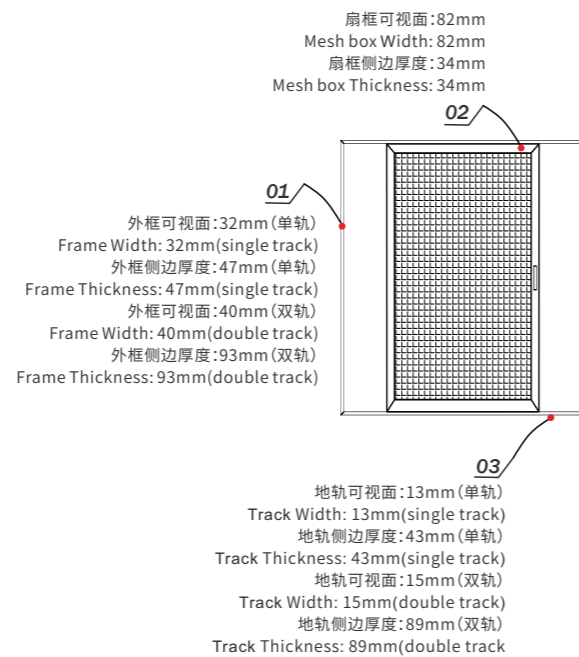

H12 极窄无轨平移纱门

H12 Ultra-narrow Trackless Sliding Screen Door



产品特色 product characteristic

极窄工艺 无缝美学

Ultra-narrow craftsmanship Seamless aesthetics

极窄边框, 视野更宽广, 隐藏五金设计, 可视面无可见五金, 外观简约。Ultra-narrow frame, wider field of vision. Hidden hardware design and simple appearance, no visible hardware on the visible surface.

无轨推拉 无碍出行

Trackless push-pull Barrier-free travel

纱门无底轨, 通行无障碍; 缓冲设计, 静音防撞, 稳固耐用。Trackless screen door, barrier-free travel; Cushioning design, quiet and anti-collision, more stable and durable.

多扇联动 自在开合

Multi-fan linkage Open and close freely

五种开启方式, 左右互推创新设计, 可多扇纱门联动, 可做移动屏风, 随心开合。Five opening methods, left and right push each other innovative design. Be linked with multiple screen doors and be used as a mobile screen, easy to open and close.

产品参数 product information

适配网材 Screen Mesh	进口28目编物网 28-mesh Fabricated Mesh
开合方式 Opening Method	单轨单扇 Single Track Single Mesh 单轨对碰 Single Track Double Meshes 双轨四扇 Double Tracks Double Meshes 双轨双扇 Double Tracks Four Meshes
尺寸范围 Size Range	单拉 (single): MAX: W:2500xH:2800 对碰 (double): MAX: W:5000xH:2800
框体颜色 Profile Color	星际黑丝 Metal Brushed Black
适用门型 Application	平开门、推拉门、折叠门、内开门 Casement Doors, Sliding Doors, Folding Doors, Inward-opening Doors

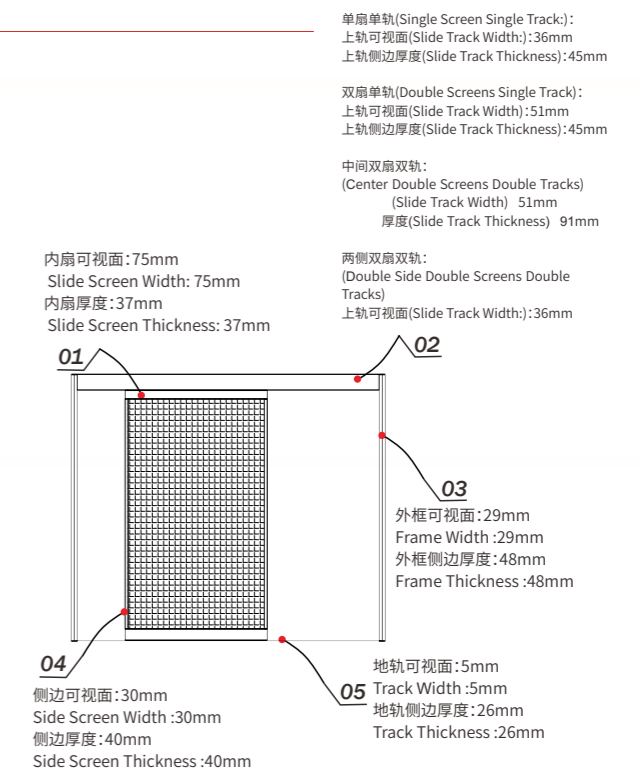

H12z 智能极窄平移纱门

H12Z Electric Intelligent Ultra-narrow Trackless Sliding Screen Door



产品特色 product characteristic

无轨平移 智控由我

Trackless sliding Easy to control

智能化无轨平移纱门, 标配手机智控、微波感应控制, 遇阻防夹, 便捷安全。

Standard equipped with cell phone intelligent control and microwave sensor control. In case of power failure, there are manual and anti-clamping functions, convenient and safe.

FOC矢量算法 敏捷响应

FOC vector algorithm Agile Response

自动驾驶、精密仪器同款FOC矢量控制算法, 系统开合响应在0.2秒以内。

Same FOC vector control algorithm for autopilot and precision instruments, system open/close response within 0.2 seconds.

家居智能互联 便捷高效

Home connectivity in the palm of your hand

可实现全屋智能家居联动, 弹指之间, 掌控智慧生活。

Realize whole-house intelligent home linkage, control your life at your fingertips.

产品参数 product information

适配网材 Screen Mesh	日本进口28目筛物网 Japanese 28-mesh Fabricated Mesh
开合方式 Opening Method	单轨单扇 Single Track Single Mesh 单轨对碰 Single Track Double Meshes 双轨四扇 Double Tracks Double Meshes 双轨双扇 Double Tracks Four Meshes
尺寸范围 Size Range	单拉 (single): MAX: W:2500xH:2800 对碰 (double): MAX: W:5000xH:2800
框体颜色 Profile Color	星际黑丝 Metal Brushed Black
适用门型 Application	推拉门、平移门、内倾侧滑门 Sliding Doors, Horizontal Sliding Doors, Inward Tilting Side Sliding Doors

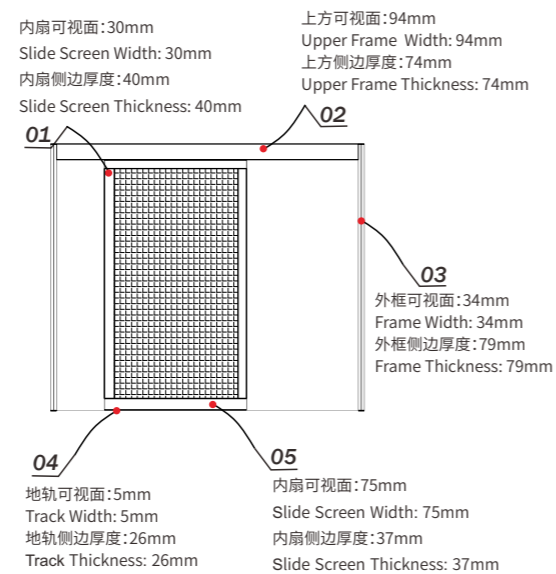

H6 双向联动折叠纱门

H6 Bi-directional Sliding Screen Door



产品特色 product characteristic

双向联动 单手操作启闭

Bi-directional linkage
One-handed opening and closing

双向联动设计, 操作便捷, 单手推拉开合, 可任意悬停; 折叠纱门, 空间更开阔。

Bi-directional linkage design, easy to operate, one-handed push and pull to open and close, can be arbitrarily suspended. Folding screen door, more open space.

极薄框体 便捷镶嵌安装

Ultra thin frame Easy inlay installation

框体厚度仅18mm, 超薄框体, 适用于空间狭窄的特定门洞, 容易镶嵌安装。

Thickness of the frame is only 18mm with ultra-thin frame, suitable for specific doorways with narrow space, and easy to set and install.

产品参数 product information

适配网材 Screen Mesh	PET折叠纱网 PET Folding Mesh
开合方式 Opening Method	对碰 Double
尺寸范围 Size Range	MAX: W:4000xH:3000
框体颜色 Profile Color	定制色 Customized Color
适用门型 Application	平开门、推拉门、折叠门 Casement Doors, Sliding Doors, Folding Doors

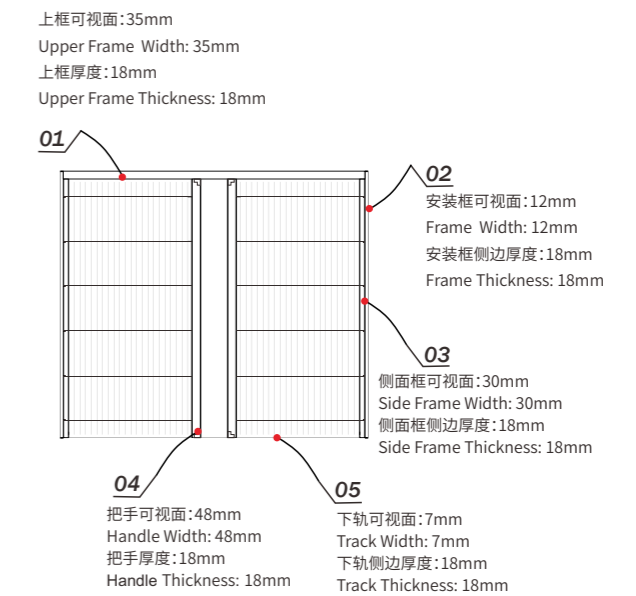

H22 滑盖小平开

H22 Sliding Cover Casement Screen Window



产品特点 product characteristic

多点锁闭 安全防护

Multi-point locking system for enhanced safety and protection

联动双点锁闭结构、配备锁舌及安全钥匙，框扇设有保护圆角，保护安全。
Linked dual-point locking mechanism, equipped with a latch and safety key. The frame has protective rounded corners for enhanced safety.

快速拆卸 清洗方便

Quick disassembly Easy cleaning

10秒快速拆装，让清洗更方便，让空气更清新。
10-second quick disassembly makes cleaning easier and keeps the air fresher.

产品参数 product information

适配网材 Screen Mesh	20高清金刚网 20 High-definition Security Mesh 特钢网 Specialized Stainless Steel Mesh
开合方式 Opening Method	内开 Inward Open
尺寸范围 Size Range	MAX: W:900xH:1500
框体颜色 Profile Color	星空灰丝 Metal Brushed Grey
适用窗型 Application	平开窗 Casement Windows

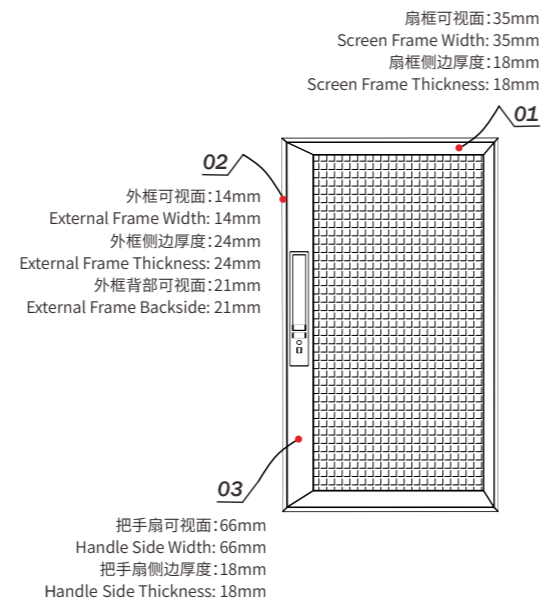

H2 回卷隐形纱门

H2 Retractable Invisible Screen Door



产品特点 product characteristic

多功能回卷纱网 自洁去污

Multifunctional retractable screen with self-cleaning function

回卷开合不占空间，内置自洁毛刷，不粘污垢更耐脏。
The retractable screen opens and closes without taking up space. With a built-in self-cleaning brush, the mesh is cleaned with just one pull, resistant to dirt and stains.

弹簧与油压减速 启闭顺畅

The spring and hydraulic deceleration ensure smooth opening and closing

10万+次开合测试，油压减速装置，匀速关闭，经久耐用。
The hydraulic deceleration device ensures uniform closing, providing long-lasting durability.

防风设计 不惧强风

Windproof design Resistant to strong winds

独特纱网防脱设计，抗风压，在强风情况下，纱网不脱轨。
Unique mesh anti-detachment design, the mesh stays in the track even in strong winds.

产品参数 product information

适配网材 Screen Mesh	高定玻纤网 High-end Customized Fiberglass Mesh 卷帘专用网 Roller Shutter Special Mesh 4K高清网 4K High-definition Mesh 美国飞佛网 America Phifer 宠物网 Anti-pet Grip Mesh 日本48目多功能网 Japan 48-mesh Net 金属芯网 Metal Core Mesh 防雾霾网 Anti-smog Mesh
开合方式 Opening Method	左右拉 Sliding
尺寸范围 Size Range	单拉 (single) : MAX: W:2900xH:2800 对拉 (double) : MAX: W:5800xH:2800 (网材不同, 最大极限尺寸有差异) The max limiting size varies depending on the mesh material
框体颜色 Profile Color	星际黑丝 Metal Brushed Black 星空灰丝 Metal Brushed Grey 铂灰丝 Metal Brushed Platinum Gold 月光灰丝 Metal Brushed Light Grey 哑光金属灰 Matt Grey 哑光金属棕 Matt Brown 哑光白 Matt White
适用门型 Application	平开门、推拉门、折叠门、内开门 Casement Doors, Sliding Doors, Folding Doors, Inward-opening Doors

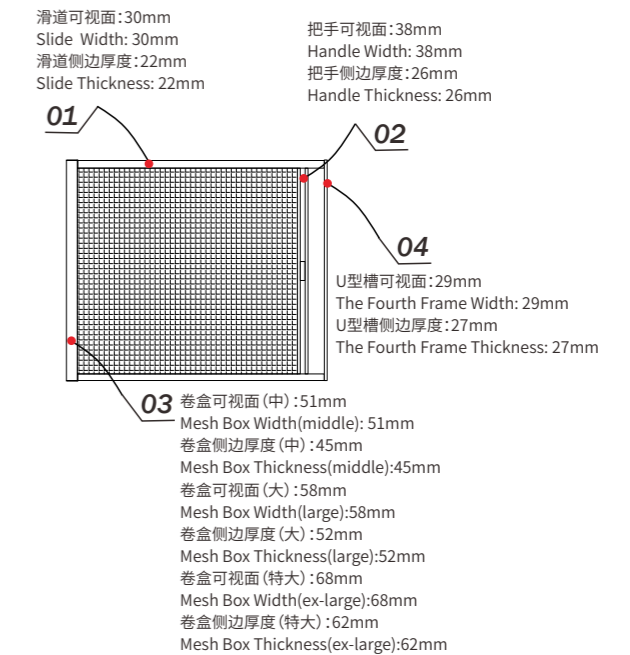

H2 回卷隐形纱窗



产品特点 product characteristic

多功能回卷纱网 自洁去污

Multifunctional retractable screen with self-cleaning function

回卷开合不占空间, 内置自洁毛刷, 不粘污垢更耐脏。
The retractable screen opens and closes without taking up space. With a built-in self-cleaning brush, resistant to dirt and stains.

弹簧与油压减速 启闭顺畅

The spring and hydraulic deceleration ensure smooth opening and closing

10万+次开合测试, 油压减速装置, 匀速关闭, 经久耐用。
The hydraulic deceleration device ensures uniform closing, providing long-lasting durability.

防风设计 不惧强风

Windproof design Resistant to strong winds

独特纱网防脱设计, 抗风压, 在强风情况下, 纱网不脱轨。
Unique mesh anti-detachment design, the mesh stays in the track even in strong winds.

产品参数 product information

适配网材 Screen Mesh	高定玻纤网 High-end Customized Fiberglass Mesh 卷帘专用网 Roller Shutter Special Mesh 4K高清图网 4K High-definition Mesh 美国飞佛网 America Phifer 宠物网 Anti-pet Grip Mesh 日本48目多功能网 Japan 48-mesh Net 电纳磁8# 8# Flexible Security Mesh 防雾霾网 Anti-smog Mesh 厨房专用网 High Polymer Kitchen Mesh
开合方式 Opening Method	左右拉、上下拉 Up to Down Pull, Side Pull
尺寸范围 Size Range	单拉 (single) :MAX: W:1799xH:1799 对碰 (double) :MAX: W:3598xH:1799 (网材不同, 最大极限尺寸有差异) The max limiting size varies depending on the mesh material
框体颜色 Profile Color	星际黑丝 Metal Brushed Black 星空灰丝 Metal Brushed Grey 铂灰丝 Metal Brushed Platinum Gold 月光灰丝 Metal Brushed Light Grey 哑光金属灰 Matt Grey 哑光金属棕 Matt Brown 哑光白 Matt White
适用窗型 Application	平开窗、推拉窗、悬窗、折叠窗、内开内倒窗等 Casement Windows, Sliding Windows, Inward Opening and Reversing Window

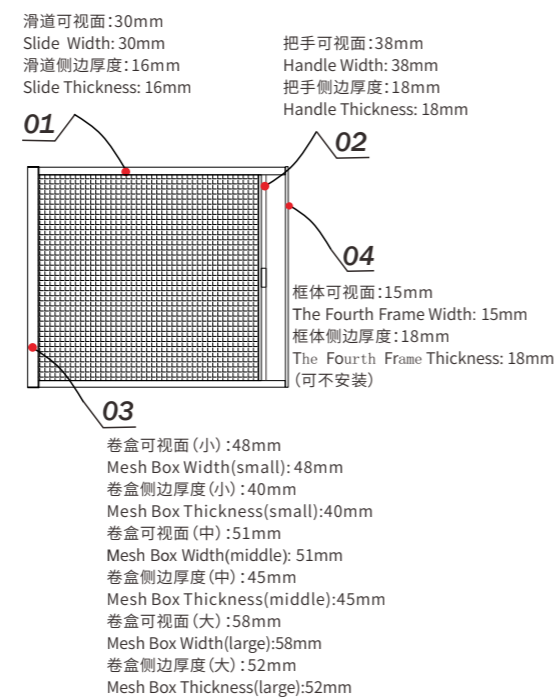

H2z 电动回卷纱窗



产品特点 product characteristic

免布线电动控制系统 安装省心

Wiring-free motorized control system Easy to install

免布线控制系统, 解决现场布线烦恼; 长效续航, 充电一次可使用3-6个月(按每天4个行程计算)。
Wiring-free control system, solve the hassle of wire installation; long-lasting battery life, charging once can be used for 3-6 months (Based on 4 trips per day).

远距离操控 启闭便捷

Remote control Easy to open and close

可实现35m长距离内遥控控制, 室内操控不受限, 开合更便捷。
35 meters long distance remote control, no limit for indoor controlling, conveniently open and close.

产品参数 product information

适配网材 Screen Mesh	高定玻纤网 High-end Customized Fiberglass Mesh
开合方式 Opening Method	上下拉 Up to Down Pull
尺寸范围 Size Range	MIN: W:550xH:600 MAX: W:1500xH:1800
框体颜色 Profile Color	哑光金属灰 Matt Grey
适用窗型 Application	平开窗、推拉窗 Casement Windows, Sliding Window

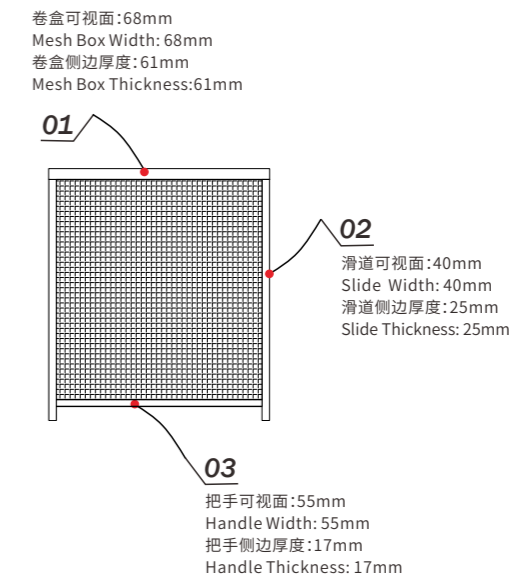

H5 TITATITA回卷纱窗

H5 TITATITA Retractable Invisible Screen Window



产品特点 product characteristic

意大利原装进口 安全防窥

Imported from Italy Safe from prying eyes

防窥视纱网, 通透采光, 外视不透影, 守护隐私安全。
Anti-peeping screen mesh, permeable to light, opaque from outside, safeguarding privacy and security.

自适应结构 安装包容性强

Adaptive structure Inclusive installation

自适应结构, 主动适应各种不标准窗户洞口, 安装容错率高。
Adaptive structure, actively adapting to a variety of non-standard windows for easy installation.

单手按压解锁 用户友好

One-handed press to unlock User-friendly

独特按压启闭方式, 操作简单, 锁闭五金全隐形, 简洁美观。
Unique press open/close method, easy to operate, invisible locking hardware, simple and beautiful.

产品参数 product information

适配网材 Screen Mesh	防窥视网 Anti-peeping Mesh 高定玻纤网 High-end Customized Fiberglass Mesh
开合方式 Opening Method	上下拉 Up to Down Pull
尺寸范围 Size Range	MAX: W:1000xH:1500
框体颜色 Profile Color	哑光金属灰 Matt Grey
适用窗型 Application	平开窗、悬窗 Casement Windows, Hinged Windows

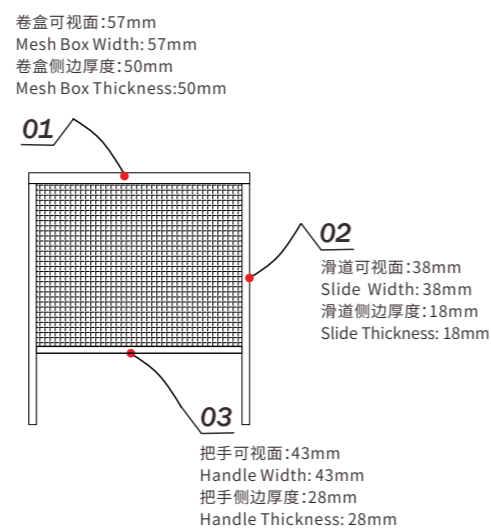

特色网材 Types of Mesh

定制玻纤网

网孔目数: 16*18;

不影响采光: 在保证防虫效果的同时, 不影响室内采光, 提升居住舒适度。

耐用持久: 使用寿命长, 减少更换频率, 节省成本。

环保健康: 采用环保无毒材质的PVC涂层, 符合现代健康家居的需求。

网纱展示区
130*160MM
镂空, 嵌入材料

Customized Fiberglass Mesh¹

Mesh Count: 16x18. Effectively prevents insects while allowing natural light indoors, enhancing living comfort.
Durable and long-lasting: Offers an extended lifespan, reducing the need for frequent replacements and saving costs.
Eco-friendly and healthy: Made with eco-friendly, non-toxic PVC coating, meeting the needs of modern healthy living environments.

网纱展示区
130*160MM
镂空，嵌入材料

特色网材 Types of Mesh

高定玻纤网¹

网材纬向18目，经向20目。细密防虫、透光性佳、抗拉性强、网面平整。
同比市面上其他玻纤网：更挺括，更平整，恢复度更好，不易变形。
环保无毒、易清洗。
PVC涂层玻璃纤维持久防护，不易老化。

网纱展示区
130*160MM
镂空，嵌入材料

High-end Customized Fiberglass Mesh

The mesh material has 18 meshes in the weft direction and 20 meshes in the warp direction. It is finely woven for insect prevention, offers excellent light transmission, has strong tensile strength, and maintains a flat surface. Compared to other fiberglass meshes on the market, it is stiffer, smoother, has better recovery, and is less prone to deformation. It is eco-friendly, non-toxic, and easy to clean. The PVC-coated fiberglass provides long-lasting protection and is resistant to aging.

网纱展示区
130*160MM
镂空，嵌入材料

特色网材 Types of Mesh

卷帘专用网

采用高特性纤维为原料，特殊高温定型工艺形成，强度比普通纤维高数倍；对放射线具有优异的遮挡作用，是核电站的遮挡板主要原料，在超低温(-105°C)下仍保持优良的冲击性能。

0.14mm丝径，26目网孔设计，阻挡蚊虫、视野高清、防护性好、可承受20N强度的单丝，抗强风。应用范围广，丝与丝之间粘连牢固、不捋丝、经久耐用、使用寿命长。

网纱展示区
130*160MM
镂空，嵌入材料

Roller Shutter Special Mesh¹

Made from high-performance fibers using a special high-temperature shaping process, this mesh is several times stronger than ordinary fibers. It provides excellent radiation shielding, making it the primary material for shielding panels in nuclear power plants. Even at extremely low temperatures (-105°C), it maintains excellent impact resistance. With a wire diameter of 0.14mm and a 26-mesh design, it effectively blocks mosquitoes while offering clear visibility and strong protection. It can withstand a tensile strength of 20N per monofilament and is wind-resistant. This mesh has a wide range of applications, with tightly bonded fibers that do not unravel, ensuring durability and a long lifespan.

网纱展示区
130*160MM
镂空，嵌入材料

特色网材 Types of Mesh

美国飞佛网¹

飞佛网每一根细丝上都喷涂耐腐蚀树脂材料，以保证纱网的色彩、柔韧性、抗腐蚀能力。纬向14目，经向18目，加之专利水棚技术，不挂雨水，视野更加清晰。通过了1200小时的QUV加速老化测试，以及GREENGUARD®的室内空气质量认证。

网纱展示区
130*160MM
镂空，嵌入材料

America PhiferTM

Each Phifer mesh is sprayed with corrosion-resistant resin material to ensure the color, flexibility, corrosion resistance, and extended service life of the screen. With 14 meshes in the weft direction and 18 meshes in the warp direction, combined with patented water shed technology, it does not retain rainwater and provides clearer vision. It has passed the 1200-hour QUV accelerated aging test and GREENGUARD® indoor air quality certification.

网纱展示区
130*160MM
镂空，嵌入材料

特色网材 Types of Mesh

进口28目编物网TM

丝径0.19毫米, 高效物理防蚊。原材料为PET单丝(聚酯纤维丝)也可称为涤纶单丝, 这种材料的优势; 在较宽的温度范围内具有优异的物理机械性能, 长期耐高温可达120度, 绝缘性优良, 抗冲击性能好, 抗蠕变性、耐疲劳性、耐摩擦性优良。PET材料本身具有抗老化、抗紫外线的性能。通过纳米覆层技术, 使纳米粒子均匀牢固的与纱网基材完美结合, 减少灰尘与纱网的表面接触面积, 减低两者物质的摩擦系数从而达到不易粘灰自清洁的效果。颠覆传统纱网, 达到透光、通风、90%防蚊虫、高效率防尘。

网纱展示区
130*160MM
镂空，嵌入材料

28-mesh Fabricated Mesh¹

Wire diameter 0.19 mm, efficient physical anti-mosquito. The raw material is PET monofilament (polyester fiber filament) can also be called polyester monofilament.

The advantages of this material in a wide range of temperatures with excellent physical and mechanical properties, long-term high temperature resistance up to 120 degrees, excellent insulation, good impact resistance, creep resistance, fatigue resistance, friction resistance is excellent. PET material itself has anti-aging, UV resistance.

By using nano-coating technology, nanoparticles are uniformly and securely integrated with the mesh substrate, reducing the surface contact area between dust and the mesh. This lowers the friction coefficient between the two materials, resulting in a self-cleaning effect that resists dust adhesion. This innovation revolutionizes traditional mesh, achieving transparency, ventilation, 90% mosquito prevention, and high-efficiency dust resistance.

网纱展示区
130*160MM
镂空，嵌入材料

特色网材 Types of Mesh

日本48目多功能网¹

日本进口NBC 高密度48目防虫网, 丝径仅0.125毫米, 网孔仅有400微米, 有效防止蚊虫侵扰。采用Nafiec技术和光触媒技术, 高清高透, 视野更好, 易清洁不沾灰, 清水即可清洁。单扇尺寸最宽1.5米。

网纱展示区
130*160MM
镂空，嵌入材料

Japanese 48-mesh Fabricated Mesh¹

Japanese NBC high-density 48-mesh insect-proof net, with a mesh diameter 0.125mm and mesh openings of only 400 micrometers, effectively prevents midge intrusion. Utilizing Nafiec technology and photocatalytic technology, it offers high-definition clarity and transparency, providing better visibility. It is easy to clean, resistant to dust, and can be cleaned with just water. The maximum size for a single fan is 1.5 meters.

网纱展示区
130*160MM
镂空，嵌入材料

特色网材 Types of Mesh

宠物网¹

涤纶纱PVC聚酯涂层平织网面，强度更高，同时保持良好的外部可见性和空气流通性。可防止宠物猫和狗对纱网造成的撕裂和损坏。宠物网可以做到的尺寸单扇宽1.5米。

网纱展示区
130*160MM
镂空，嵌入材料

Pet Mesh¹

Polyester yarn with a PVC polyester coating in a plain weave, offers higher strength while maintaining good visibility and air circulation. It can prevent tearing and damage caused by pets like cats and dogs. The pet mesh is available in sizes with a single fan width of 1.5 meters.

网纱展示区
130*160MM
镂空，嵌入材料

特色网材 Types of Mesh

4K高清网¹

丝径0.01毫米, 48目高密度防虫网, 网孔仅400um, 可有效阻止最小的飞翔型昆虫侵入, 高效物理防蚊。
纱网采用特殊工艺达到不易沾灰、高清通透、易清洗功能。
纱网网面平整, 单丝复合组成, 强度更高。

网纱展示区
130*160MM
镂空，嵌入材料

4K High-definition Mesh

48 high-definition mesh with mesh diameter 0.01mm, and mesh holes only 400 micrometers, effectively preventing the smallest flying insects from invading, providing efficient physical mosquito protection. The mesh adopts a special process to achieve features such as resistance to dust, high clarity, and easy cleaning. The mesh has a smooth surface and is composed of composite single wires, providing higher strength.

网纱展示区
130*160MM
镂空，嵌入材料

特色网材 Types of Mesh

超清洗-厨房专用高透网

高分子纤维，网孔数目:40目，小孔成像原理，视野无阻隔。网孔细密，超细线径(0.12mm)。采用高分子纤维，具有光催化功能的纤维表面处理，形成高透视、不易沾灰、易清洗、疏水性好的性能纱网

网纱展示区
130*160MM
镂空，嵌入材料

Ultra Clean - Kitchen Specialty Mesh¹

Polymer fibers with a mesh count of 40, using a small hole imaging principle for an unobstructed view. The mesh is densely packed with an ultra-fine line diameter of 0.12mm. The polymer fibers are treated with a photocatalytic surface treatment, resulting in a mesh with high transparency, resistance to dust, easy cleaning, and excellent hydrophobic properties.

网纱展示区
130*160MM
镂空，嵌入材料

特色网材 Types of Mesh

进口防雾霾网¹

纳米纤维材料, 由直径介于 500 纳米到 800 纳米之间的超细纤维组成, 比人的头发丝还要细 1000 倍。超高效过滤性, 对比市面主动静电防霾网, 可更有效防雾霾、灰尘、紫外线、过敏源、部分二手烟和尾气。对 1 微米大小的颗粒 (例如汽车尾气中的部分颗粒) 的过滤效率高达 92.83%, 对 2.5 微米大小的颗粒 (雾霾和工业废气) 的过滤效率高达 98.23%。过滤效率已得到德国实验室 TÜV SÜD 的检测报告。

网纱展示区
130*160MM
镂空，嵌入材料

Anti-smog Mesh¹

Made of nanofiber material, composed of ultrafine fibers with diameters ranging from 500 nanometers to 800 nanometers, which are 1,000 times thinner than a human hair. With ultra-high filtration efficiency, it is more effective in protecting against smog, dust, ultraviolet rays, allergens, some secondhand smoke, and exhaust fumes compared to common electrostatic smog-resistant meshes on the market.

The filtration efficiency reaches up to 92.83% for particles as small as 1 micron (such as some particles found in vehicle exhaust) and up to 98.23% for 2.5-micron particles (such as smog and industrial emissions). Its filtration efficiency has been verified by a TÜV SÜD laboratory in Germany.

网纱展示区
130*160MM
镂空，嵌入材料

特色网材 Types of Mesh

防窥视网¹

丝径0.22毫米，网孔数目20目，室外面银色，室内面黑色，PET材质，有效使用年限不低于6年。经过独有的方法处理使得纱网的室外面附着金属银离子，进而利用银离子的光反射作用，阻挡光线的能见度，达到遮光隐形的效果；相反在纱网室内面处理成黑色，增加了纱网的透视度，真正实现不影响内部视线的前提下达到防隐私泄露的功能。

网纱展示区
130*160MM
镂空，嵌入材料

Anti-peeping Mesh¹

0.22mm Wire diameter&Mesh count: 20 mesh,Silver on the outdoor side, black on the indoor side.Material: PET material.Effective service life: Not less than 6 years.
Through a unique treatment method, the outdoor surface of the mesh is coated with metal silver ions, utilizing the light reflection of the silver ions to block the visibility of light, achieving a sunshade invisible effect. Conversely, the indoor surface of the mesh is treated with black color, increasing the transparency of the mesh, truly achieving the function of preventing privacy leakage without affecting the internal line of sight.

网纱展示区
130*160MM
镂空，嵌入材料

特色网材 Types of Mesh

金属芯网¹

细密网孔1.1mmX1mm, 可阻挡任何蚊虫的干扰, 强通风性。
304金属丝与聚酯纤维经纬钢性与柔性完美组合, 平整不捋丝, 粘接牢固, 阻燃防护保安全。
经特殊技术处理, 不易沾灰、耐腐蚀、稳定性强。

网纱展示区
130*160MM
镂空，嵌入材料

Metal Core Mesh¹

With 1.1mm x 1mm mesh holes, it effectively blocks any insect interference while ensuring strong ventilation. The perfect combination of 304 metal wire and polyester fibers provides both rigidity and flexibility, resulting in a smooth surface that does not fray, with firm bonding. It is flame-resistant for safety. After special treatment, it is dust-resistant, corrosion-resistant, and highly stable.

网纱展示区
130*160MM
镂空，嵌入材料

特色网材 Types of Mesh

电纳磁8#¹

丝径0.08毫米, 20目, 美标304电纳磁金刚网。直织工艺、超薄图层, 让网面干净平滑, 视野更清晰。高透通风、不易沾灰, 耐火阻燃, 符合澳大利亚BAL-29标准。经过纳米涂层处理后再进行涂色, 不易腐蚀, 超长耐候性, 盐雾测试长达2000小时。网丝硬度强, 单丝强拉力可达2600兆, 回弹力效果好, 不变形。

网纱展示区
130*160MM
镂空，嵌入材料

8# Flexible Security Mesh¹

20-mesh with mesh diameter 0.08mm, this American Standard 304 stainless steel mesh is made by plain weave process and features an ultra-thin coating, ensuring a clean and smooth surface for clearer visibility. It offers high transparency and ventilation, resists dust accumulation, and is fire-resistant and flame-retardant, meeting the Australian BAL-29 standard. After undergoing a nano-coating treatment and coloring, it is highly resistant to corrosion and has an exceptionally long weather resistance, with a salt spray test lasting up to 2000 hours. The mesh wire has strong hardness, with a single wire tensile strength of up to 2600 MPa, excellent rebound resilience, and does not deform.

网纱展示区
130*160MM
镂空，嵌入材料

特色网材 Types of Mesh

格特网¹

国标304不锈钢网，隐形高清，防蚊防虫，防火阻燃。
高抗腐蚀性，十分适合沿海地区和高污染的城市。

网纱展示区
130*160MM
镂空，嵌入材料

Security Mesh¹

304 stainless steel mesh, invisible and high-definition, provides protection against mosquitoes and insects, and is fire-resistant. With high corrosion resistance, it is ideal for coastal areas and highly polluted cities.

网纱展示区
130*160MM
镂空，嵌入材料

特色网材 Types of Mesh

经典黑¹

丝径0.18毫米高透定格金属网, 13目, 采用国标304不锈钢, 高抗腐蚀性, 隐形高清, 线径与目数合理匹配, 采光通风俱佳。

网纱展示区
130*160MM
镂空，嵌入材料

Classic Black Metal Mesh¹

0.18mm wire diameter high-transparency fixed metal mesh with 13 mesh count, made of national standard 304# stainless steel, providing high corrosion resistance, invisible high definition, reasonable match of wire diameter and mesh count, excellent light transmission and ventilation.

网纱展示区
130*160MM
镂空，嵌入材料

特色网材 Types of Mesh¹

电纳磁11#¹

丝径0.11毫米，美标304电纳磁金刚网。直织工艺、超薄图层，让网面干净平滑，视野更清晰。高透通风、不易沾灰，耐火阻燃，符合澳大利亚BAL-29标准。经过纳米涂层处理后再进行涂色，不易腐蚀，超长耐候性，盐雾测试长达2000小时。网丝硬度强，单丝强拉力可达2600兆，回弹力效果好，不变形。

网纱展示区
130*160MM
镂空，嵌入材料

11# Flexible Security Mesh¹

With mesh diameter 0.11mm, this American Standard 304 stainless steel mesh is made by plain weave process and features an ultra-thin coating, ensuring a clean and smooth surface for clearer visibility. It offers high transparency and ventilation, resists dust accumulation, and is fire-resistant and flame-retardant, meeting the Australian BAL-29 standard. After undergoing a nano-coating treatment and coloring, it is highly resistant to corrosion and has an exceptionally long weather resistance, with a salt spray test lasting up to 2000 hours. The mesh wire has strong hardness, with a single wire tensile strength of up to 2600 MPa, excellent rebound resilience, and does not deform.

网纱展示区
130*160MM
镂空，嵌入材料

特色网材 Types of Mesh

电纳磁25#¹

丝径0.25毫米，美标304电纳磁金刚网。直织工艺、超薄图层，让网面干净平滑，视野更清晰。高透通风、不易沾灰，耐火阻燃，符合澳大利亚BAL-29标准。经过纳米涂层处理后再进行涂色，不易腐蚀，超长耐候性，盐雾测试长达2000小时。网丝硬度强，单丝强拉力可达2600兆，回弹力效果好，不变形。

网纱展示区
130*160MM
镂空，嵌入材料

25# Flexible Security Mesh¹

With mesh diameter 0.25mm, this American Standard 304 stainless steel mesh is made by plain weave process and features an ultra-thin coating, ensuring a clean and smooth surface for clearer visibility. It offers high transparency and ventilation, resists dust accumulation, and is fire-resistant and flame-retardant, meeting the Australian BAL-29 standard. After undergoing a nano-coating treatment and coloring, it is highly resistant to corrosion and has an exceptionally long weather resistance, with a salt spray test lasting up to 2000 hours. The mesh wire has strong hardness, with a single wire tensile strength of up to 2600 MPa, excellent rebound resilience, and does not deform.

网纱展示区
130*160MM
镂空，嵌入材料

特色网材 Types of Mesh

电循磁网¹

采用国标304不锈钢材质，丝径0.45mm。
表面做电泳层、中涂层、色漆层、抛光层四层工艺，乌黑亮泽，添加抗氧化抗UV成分，久不褪色，观感通透，不易沾灰尘和油污，一擦即净，长效抗锈，沿海首选。
克服了传统金刚网所带来的遮光、不透气、粘尘、难清洁、易生锈等缺点。

网纱展示区
130*160MM
镂空，嵌入材料

Electrophoretic Coating Security Mesh¹

Made of national standard 304# stainless steel material with a wire diameter of 0.45mm, the surface undergoes a four-layer process including electrophoretic coating, intermediate coating, paint coating, and polishing layer. The mesh appears glossy black and incorporates anti-oxidation and UV-resistant components, ensuring long-lasting color fastness, transparency, resistance to dust and oil stains, easy cleaning, long-term rust resistance, making it the preferred choice for coastal areas. It overcomes the shortcomings of traditional diamond mesh such as shading, poor air permeability, dust adhesion, difficult cleaning, and susceptibility to rust.

网纱展示区
130*160MM
镂空，嵌入材料

特色网材 Types of Mesh

特钢网¹

丝径0.18毫米高清非定格金属网，13目，采用国标304不锈钢，高抗腐蚀性，隐形高清，采光通风俱佳。
单丝上色再编制工艺，保证纱网交叉点无焊接、纯方孔，每根丝都是一个圆柱体可单独抽出，表面光滑、不易沾灰。

网纱展示区
130*160MM
镂空，嵌入材料

Specialized Stainless Steel Mesh¹

0.18mm wire diameter high-definition non-fixed metal mesh with 13 mesh count, made of national standard 304# stainless steel, providing high corrosion resistance, invisible high definition, excellent light transmission and ventilation. The single-wire coloring and re-weaving process ensures that there is no welding at the intersections of the mesh, resulting in pure square holes, with each wire being a separate cylinder that can be individually extracted. The surface is smooth and not easily stained with dust.

网纱展示区
130*160MM
镂空，嵌入材料

特色网材 Types of Mesh

60防护金刚网¹

丝径0.6毫米防护金刚网，网孔数目：13目，采用国标304不锈钢，高抗腐蚀性，防暴力入侵。纱网采用低温弛力退火工艺，经纬线横平竖直，网孔大小均匀，结构呈正方形，且形态稳定不易变形。

网纱展示区
130*160MM
镂空，嵌入材料

60 Security Mesh¹

0.6mm wire diameter protective security mesh with 13 mesh count, made of national standard 304# stainless steel, providing high corrosion resistance and protection against violent intrusion. The mesh undergoes low-temperature stress-relief annealing process, ensuring straight warp and weft lines, uniform mesh size, and a stable structure that is resistant to deformation.

网纱展示区
130*160MM
镂空，嵌入材料

瓷泳型材色板

Ceramic Electrocoating Profile Color Board

瓷泳银河系列产品选用的是日本关西涂料, 2017年日本关西消光涂料总部授予供应商战略合作伙伴。在2019年获得中国质量认证中心颁发的电泳涂漆型材“低碳产品认证证书”。
高硬度, 耐酸碱腐蚀性, 耐碱测试在300小时以上, 良好的耐候性可适应各种严苛气候条件。型材外观靓丽, 质感丝滑, 提升整体居家档次。

The ceramic electrocoating series products utilize Kansai Paint from Japan. In 2017, Kansai Paint's matte coating headquarters in Japan awarded our supplier a strategic partnership. In 2019, it received the "Low Carbon Product Certification" for electrophoretic coating profiles from the China Quality Certification Center. The products feature high hardness, excellent resistance to acid and alkali corrosion with alkali resistance tested to exceed 300 hours. And superior weather resistance allows them to adapt to various harsh climatic conditions. The profiles have a sleek and smooth appearance, enhancing the overall aesthetic of home decor.

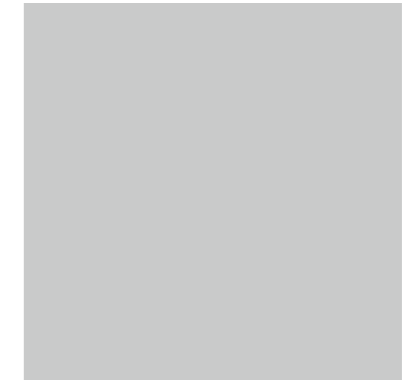

银河瓷-星际黑丝
Metal Brushed Black



银河瓷-月光灰丝
Metal Brushed Light Grey

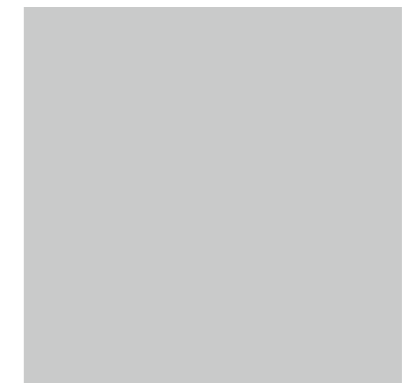

银河瓷-星空灰丝
Metal Brushed Grey

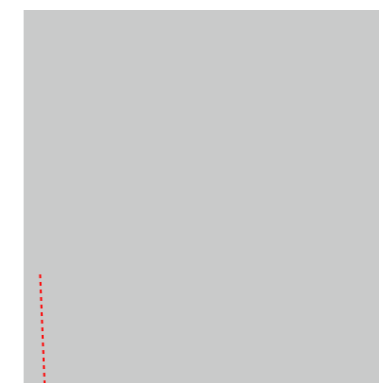

银河瓷-铂灰丝
Metal Brushed Platinum Gold

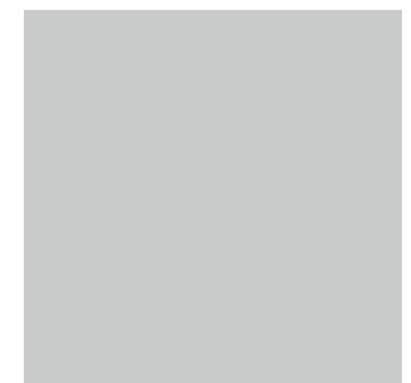

银河瓷-星河咖
Smooth Brown

板材凹槽, 板材尺寸50*50mm

选一个银色的纸张封口



喷涂型材色板

Powder-coated Profile Color Board

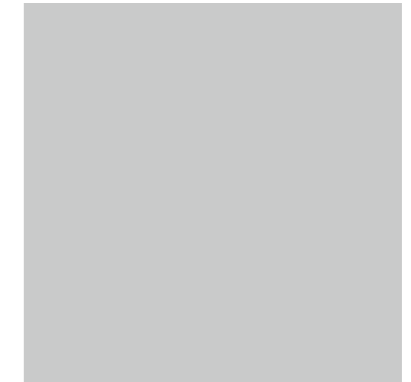

哑光白
Matt White

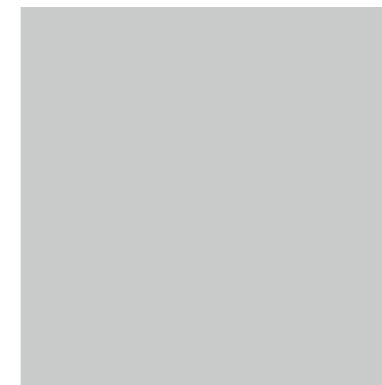

哑光棕
Matt Brown

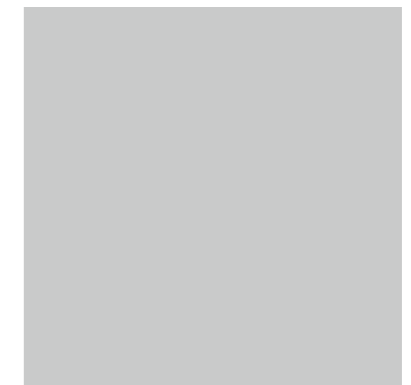

哑光金属灰
Matt Grey



棕砂纹
Brown Sand Color

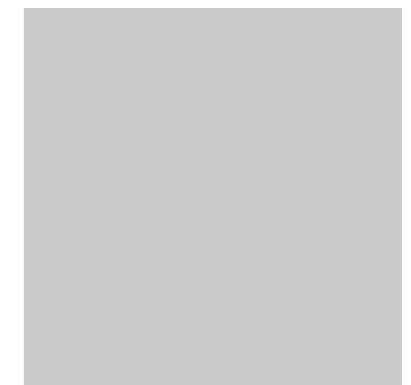

灰砂纹
Gray Sand Color

板材凹槽，板材尺寸50*50mm

选一个银色的纸张封口

